

# VZ-ENB & EHB SERIES

## 49" and 55" PROFESSIONAL

---

LED CCTV VIDEO WALL MONITOR **USER MANUAL**

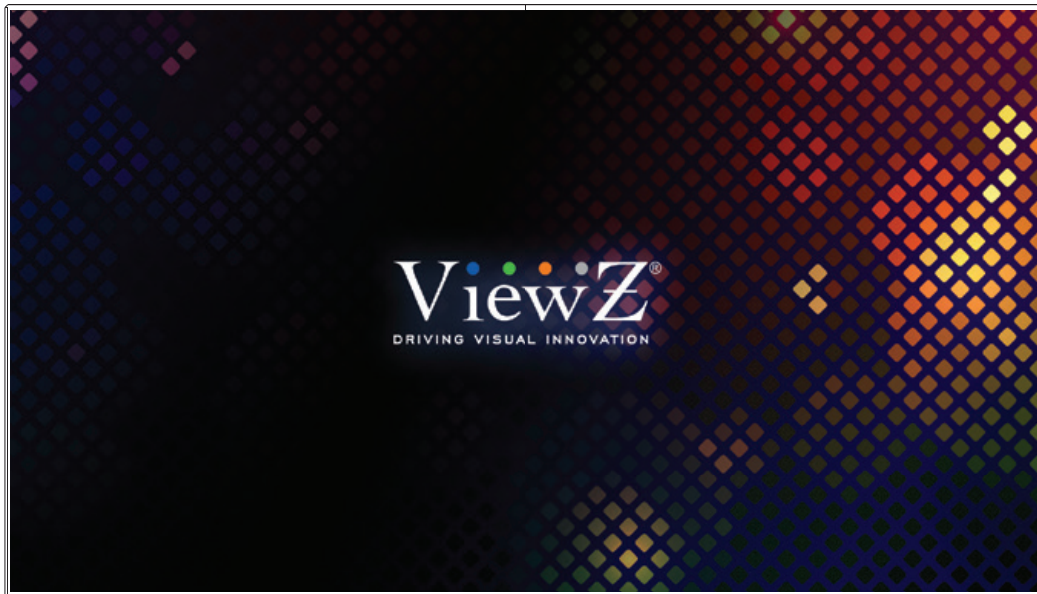

**ViewZ**<sup>®</sup>  
[www.viewzusa.com](http://www.viewzusa.com)

Please read this manual thoroughly before use, and keep it handy for future reference.

# CONTENTS

<b>Safety Instruction</b>	3
1. Mark Indication & Substance	4
2. Warning & Caution	4
3. FCC RF INTERFERENCE STATEMENT	6
<b>Installation</b>	7
1 Features	8
2. Interface, Resolution & Refresh Rate	9
<b>Function</b>	10
1. Remote Control Function	10
2. Daisy Chain Configuration	11
3. OSD Control and Function	12
<b>Mounting Guide</b>	18
<b>RS232 (RJ-45) Pin Map</b>	19
<b>Specification</b>	20
<b>Trouble Shooting</b>	21
<b>RMA</b>	22
<b>Warranty</b>	24

# SAFETY INSTRUCTIONS

## Important Safety Instructions

1. **Read all warnings.**
2. Follow all instructions to ensure longevity of monitor.
3. Do not place the monitor near water.
4. Clean only with dry cloth.
5. Do not block any ventilation openings. Install in accordance with the manufacturer's instructions.
6. Do not install near any heat sources such as radiators, heat registers, stoves, or other heat generating devices.
7. Do not override the safety purpose of the polarized or grounding-type plug.
8. A polarized plug has two blades with one wider than the other.
9. A grounding type plug has two blades and a third grounding prong.
10. The wide blade or the third prong is provided for your safety.
11. If the provided plug does not fit into your outlet, consult with electrician for replacement of the outlet.
12. Protect the power cord from being walked on or pinched particularly at plugs, convenience receptacles and the point where it connects to the monitor.
13. Only use attachment/accessories specified by the manufacturer.
14. Use only with the cart, stand, tripod, bracket or table specified by the manufacturer or sold with the monitor. When a cart is used, use caution when moving the cart & monitor in combination to avoid injuries.
15. Unplug the monitor during lightning storms or when unused for long periods of time.
16. Refer all servicing to qualified service personnel. Servicing is required when the monitor has been damaged in any way.



The monitor shall not be exposed to dripping or splashing and objects containing liquids such as vases shall be placed near the monitor.

The monitor should have ample distance (e.g. 10cm) from the wall for sufficient ventilation.

# SAFETY INSTRUCTIONS

## Important Safety Instructions

### Mark Indication and Substance



CAUTION : TO REDUCE THE RISK OF ELECTRICAL SHOCK,  
DO NOT REMOVE COVER (OR BACK). NO USER  
SERVICEABLE PARTS INSIDE. REFER SERVICING TO  
QUALIFIED SERVICE PERSONNEL



This symbol is intended to alert the user to the presence of uninsulated & dangerous voltage within the monitor's enclosure that may be of sufficient magnitude to constitute a risk of electric shock to persons.



This symbol is intended to alert the user to the presence of important operating and maintenance (servicing) instructions in the literature accompanying the monitor.

### Warning

- Do not use damaged or loose cables and plug.
- Do not pull the plug out by the wire nor touch the plug with wet hands.
- Use only a properly grounded plug and receptacle.
- Do not connect too many extension cords or plugs to one outlet.
- Do not excessively bend the plug and wire.
- Do not disconnect the power cord while it's still plugged into the monitor.
- Do not place any heavy objects on the power cord. Damage to the cord may cause shock or fire.
- Never open the monitor. There are no user-serviceable parts inside and opening will void warranty.
- Removing covers may expose you to dangerous shock hazards or other risks.
- Keep any heating devices away from the power cable and monitor.
- Do not place the monitor near water.
- Do not insert objects of any kind into the monitor's open slots, as they may touch dangerous voltage points.
- Please follow the laws and regulations of your municipality to dispose the monitor properly.
- Do not use the monitor in high temperature, humid, dusty or oily areas.
- Do not install the monitor where it will be exposed to continual vibration.
- Keep the plastic packaging out of children's reach.
- If any damage is detected upon first opening the box, contact agency from which you bought the monitor directly.
- If your monitor does not operate normally – in particular, if there is any unusual sound or smell coming from the monitor – unplug it immediately and contact an authorized dealer or the service center.

# SAFETY INSTRUCTIONS

## Important Safety Instructions

### Caution

- If the connector between the plug and the pin is dusty or dirty, clean it properly using a dry cloth.
- Make sure to unplug the power cord before cleaning the monitor.
- Make sure to leave a gap between monitor and wall.
- Do not drop the monitor when moving it.
- Place your monitor in a location with low humidity and minimal dust.
- Install the monitor base on a showcase or shelf so that the end of the base does not protrude from the showcase or shelf.
- Do not place the monitor on an unstable or small surface area.
- Do not install inside a vehicle.
- Disconnect the plug from the outlet during storms or lightning or if it has not been used for a long time.
- Do not try to move the monitor by pulling on the power cord.
- Do not cover the vents on the monitor.
- When moving the monitor, turn off and unplug the power cord. Make sure that all cables, including HDMI cable and cables connected to other devices, are disconnected before moving it.
- Place the monitor out of children's reach as they could damage it by hanging onto it.

### Available Temperature & Humidity

- Operating Temperature : 32°F ~ 122°F / 0°C ~ 50°C
- Operating Humidity : 20 ~ 80% RH

## Dot Defect (dead pixel) of TFT

ViewZ monitors are manufactured using high-end semiconductor technology with precision ratings of 99.9% and above. However, it may be the case that certain RGB and white pixels seem darker (or entirely unlit i.e. black).

Modern production methods cannot guarantee an absolute fault-free monitor. To this effect, no LED manufacturer can guarantee a defect free panel. A few isolated pixel or sub-pixel faults are considered tolerable and different policies exist that govern the amount of these tolerable values.

While most pixel faults occur in isolated regions, a cluster of dead pixels or sub-pixels can sometimes form for which a separate ruling applies. A cluster is defined as an area of 5x5 pixels. ViewZ's policy on pixel failure: either as an isolated fault or in the form of a cluster is outlined on the website: [www.viewzusa.com](http://www.viewzusa.com)

# FCC RF INTERFERENCE STATEMENT

## Note

This equipment has been tested and found to comply with the limits for a Class A digital device, pursuant to part 15 of the FCC Rules. These limits are designed to provide reasonable protection against harmful interference when the equipment is operated in a commercial environment.

This equipment generates, uses, and can radiate radio frequency energy and, if not installed and used in accordance with the instruction manual, may cause harmful interference to radio communications. Operation of this equipment in a residential area is likely to cause harmful interference in which case the user will be required to correct the interference at his own expense.

- Reorient or relocate the receiving antenna.
- Increase the separation between the equipment and receiver.
- Connect the equipment into an outlet on a circuit different from that to which the receiver is connected.
- Consult the dealer or an experienced radio, TV technician for help.
- Only shielded interface cable should be used.

Finally, any changes or modifications to the equipment by the user not expressly approved by the grantee or manufacturer could void the users authority to operate such equipment.

### ► DOC COMPLIANCE NOTICE

This digital apparatus does not exceed the Class A limits for radio noise emissions from digital apparatus set out in the radio interference regulation of Canadian Department of communications.

## Statement

- VGA and XGA are the registered trademark of IBM.
- VESA is the trademark of Video Electronics Standard Association.
- HDMI, HDMI logo and High-Definition Multimedia Interface (high definition multimedia digital interface) are the trademark or registered trademark of HDMI Licensing LLC.

If some company or product trademark is not particularly stated, the use of trademark has been fully recognized. Do not alter, decompile, disassemble, decode or conduct reverse engineering to the software installed in the product, or it can be deemed as breach of the law.

# INSTALLATION

## Installation Tools

The following tools may be required or recommended.

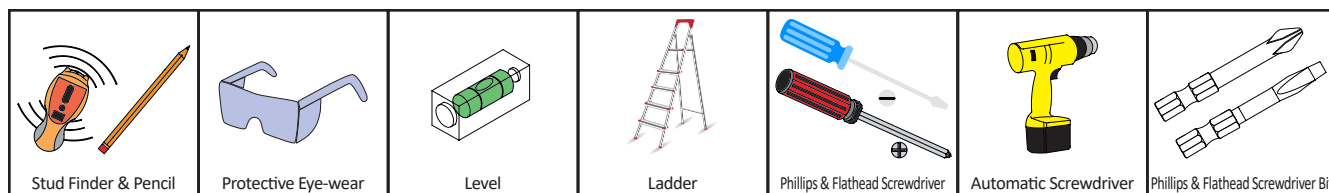

## Assembly Components - provided

Your ViewZ monitor is shipped with all proper installation hardware and components. If there are parts missing and/or damaged, please stop the installation and contact ViewZ USA at (888)-998-4399.

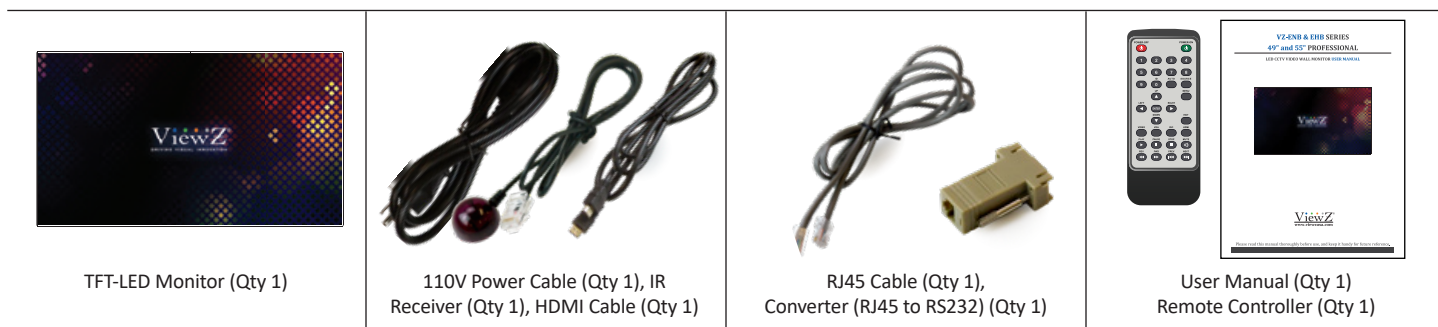

## Mounting Options

Your ViewZ monitor is compatible with ViewZ monitor mounts. For more information, please contact ViewZ USA at (888)-998-4399.

### Wall Mount

- |   |   |
|---|---|
| <ul style="list-style-type: none"> <li>Part # <b>VZ-WM71</b></li> <li>Tilting <math>-15^{\circ} \sim 0^{\circ}</math></li> <li>Universal Mount</li> <li>Compatible with <b>VZ-49/55UNBS</b></li> </ul>  | <ul style="list-style-type: none"> <li>Part # <b>VZ-XMS</b></li> <li>Max. Weight 154lb</li> <li>Universal Mount</li> <li>Compatible with <b>VZ-49/55UNBS</b></li> </ul>  |
|---|---|

### Ceiling Mount

- Part # **VZ-CMKIT-04**
  - Tilting  $-12^{\circ} \sim +5^{\circ}$
  - Universal Mount
  - 35" ~ 70"**
  - Compatible with **VZ-49/55UNBS**
- 

# FEATURES

## Features

- Creates a seamless display effect in multi-screen splicing
- Supports m rows and n columns ( $1 \leq m \leq 15$ ,  $1 \leq n \leq 15$ ) in splicing and 15 x15 at most
- Remote control of RS232 serial port: each unit supports one RS232 input and loop-out
- Integrated multi-channel video signal type - HDMI, DVI, VGA, DP, video daisy-chained by HDMI up to 15x15.
- Auto color adjustment guarantees color uniformity in multi-screen splicing with a built-in control unit to make the best adjustment of color
- The built-in picture cutting and compensation function can work with system software to accommodate large screen splicing project
- Industrial cooling fan is equipped for heat dissipation and improved reliability, supporting 24/7 operation
- Supports 8 Lan V-BY-ONE with output resolution of 3840 × 2160 @60Hz
- Using the latest V-BY-ONE driver chip, the peripheral circuit is simpler and the power consumption is lower
- USB firmware upgrade function for easy maintenance and assembly
- Full hardware architecture: no CPU and operating system
- Powerful processing
- Quick start: Less than 8 seconds
- Automatic computer-driven temperature control system with the following settings: on/off/auto/user
- Supports Full HD resolution @ 1920 x 1080
- User-friendly operation.
- Control from external source available via protocol communication (RS-232)

## Description

- Before operating the video wall monitor, please make sure you fully understand relevant prerequisites such as the specification or limitation of H/W and S/W. ViewZ shall not be responsible for loss, damage or injury caused by improper use of products.
- You are not allowed to copy, use, alter or disseminate this manual in whole or in part without prior written consent.
- Any and all product names, model names, labels, or company names used in this manual are the trademarks and registered trademarks of ViewZ.
- If you have any advice or question related to this manual, please contact our dealer, re-seller or our customer service representatives.

# CONNECT EXTERNAL EQUIPMENTS

## Interface Input Ports

The following image is the description of interface input ports

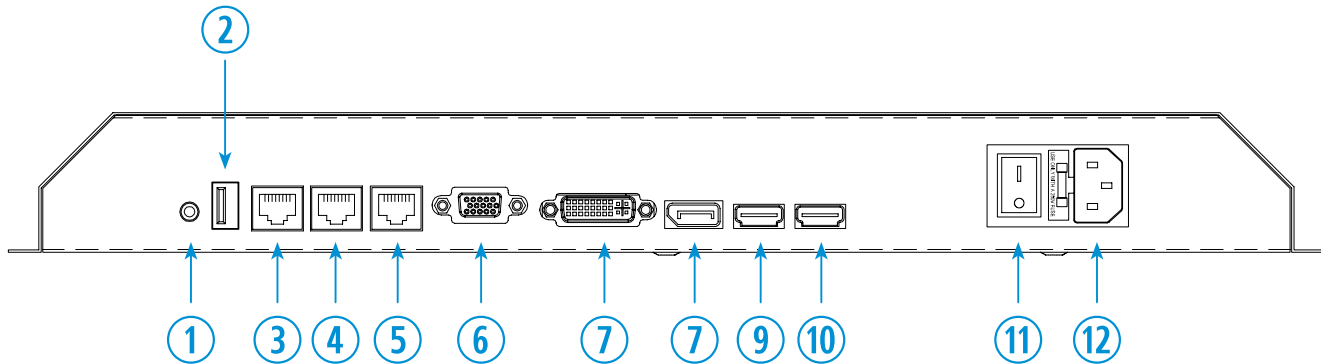

- |  |                           |
|--|---------------------------|
| 1. AUDIO OUT                                       | 7. DVI-D IN               |
| 2. USB - For upgrading SW                          | 8. DP IN                  |
| 3. RS232 (RJ-45) IN - Serial Control / IR Receiver | 9. HDMI IN                |
| 4. RS232 (RJ-45) OUT - A - Serial Control          | 10. HDMI OUT              |
| 5. RS232 (RJ-45) OUT - B - Serial Control          | 11. POWER ON / OFF Switch |
| 6. VGA IN  | 12. AC 110-240V IN        |

## Interface Resolution & Refresh Rate

Interface Input Source	Max Resolution	Refresh Rate
Display Port	3840 x 2160	30Hz
HDMI (2.0) In / Out	3840 x 2160	60Hz
DVI-D In	3840 x 2160	30Hz
VGA	1920 x 1080	60Hz

# REMOTE FUNCTION

## Remote Controller

1. **POWER ON**
2. **Number Key**- For entering ID #s
3. **ID(0)** - To setup the ID
4. **ARROW** - OSD Control
5. **ENTER** - To confirm current OSD value
6. **VGA** - To select the VGA input source
7. **DVI** - To select the DVI input source
8. **HDMI** - To select the HDMI input source
9. **No Function** - VIDEO/PLAY/PAUSE/STOP/REV./FWD/  
PREV./NEXT.
10. **MUTE** - Turn Off the Sound (Audio Out)
11. **POWER OFF**
12. **AUTO** - Automatic position adjustment
13. **SOURCE** - Change the input source
14. **MENU** - Enter the OSD
15. **EXIT** - Exit the OSD

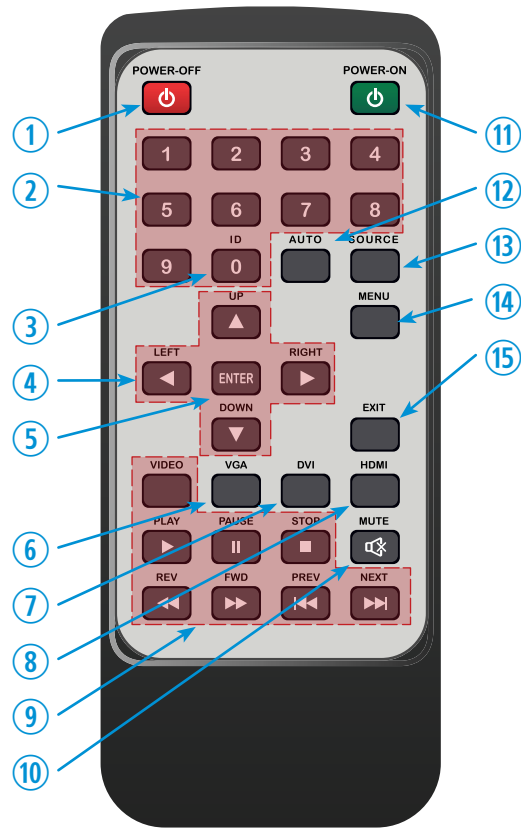

Display image, sound and custom settings can be adjusted in OSD (On Screen Display) menu by remote controller. To adjust monitor setting value:

1. Press the '**MENU**' button to enter the OSD menu.
2. Press the '**SOURCE**' button, then press the ▲ / ▼ buttons to select input source.  
Press the '**ENTER**' button to select a desired input source.
3. Press the ▲ / ▼ buttons to select the desired sub-menu. The selected sub-menu will be highlighted.
4. Press the ◀ / ▶ buttons to change the value you wish to adjust.
5. Press the '**ENTER**' button to confirm / the '**MENU/EXIT**' button to exit for saving adjustment value on sub-menu.
6. Press the '**MUTE**' button to on / off audio-out of monitor.

# RS232 CONFIGURATION

## Video Wall Wiring RS232 Configuration

User can control the video wall screens by a remote. The connection diagram of the video wall is as shown in the following figure

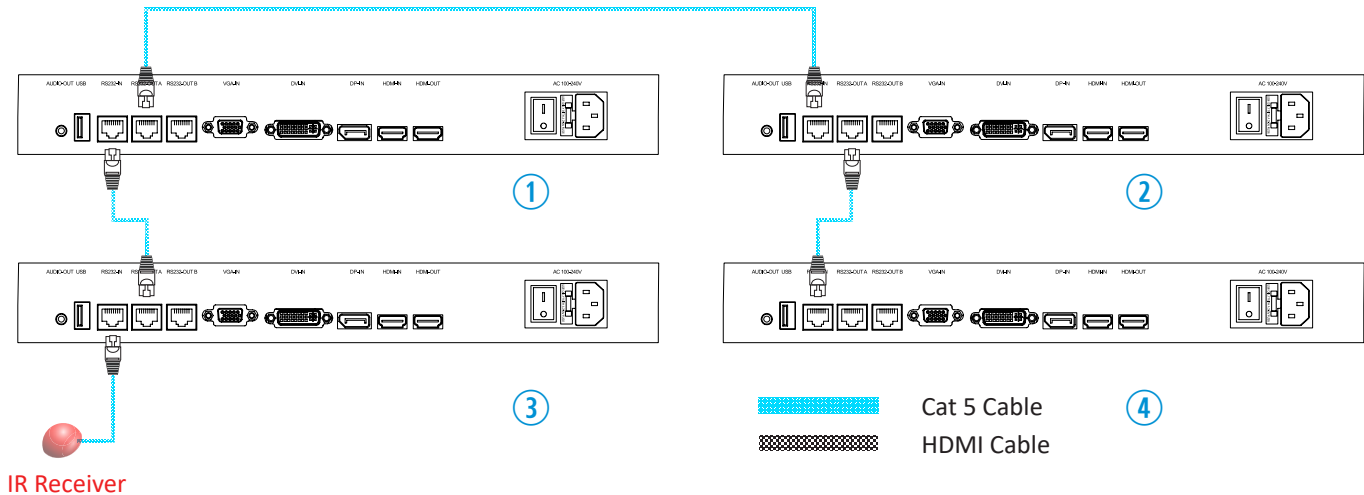

Regarding the system connection, the output channel of the matrix should correspond to the video wall screen one by one. It means the output channel of the matrix should correspond to the screen ①, and the output channel of the matrix should correspond to the screen ②, according to this wiring, as shown above as shown, the upper left corner is the screen ①, the upper right corner is the screen ②, the lower left corner is the screen ③, and the lower right corner is the screen ④.

# CONTROL AND FUNCTION

## Select Input Source

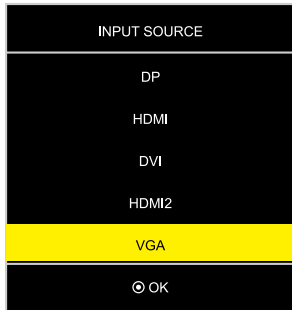

Press 'SOURCE' button on monitor or on remote controller.

Press ▲ / ▼ button to change input source and then press **ENTER** button to select input source on remote controller.

If you connect any input source, monitor will display current input source resolution and frequency.

# CONTROL AND FUNCTION

## Image

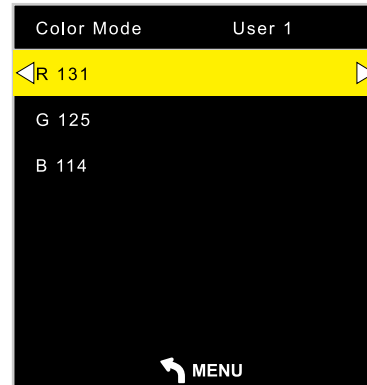
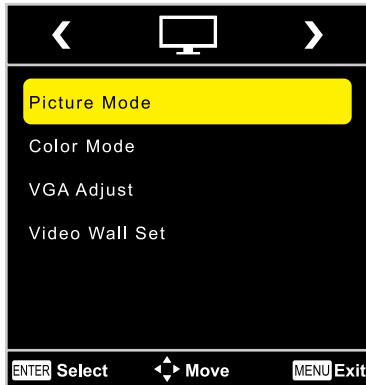

▲/▼ MOVE ◀/▶ ADJUST  
 ENTER SELECT MENU RETURN

PICTURE MODE		VALUE
DYNAMIC	Reduce contrast and sharpness	
USER 1 & 2	Applies user selected values - brightness, contrast, sharpness, tint and color	
BRIGHTNESS	Adjust the brightness	0 ~ 100
CONTRAST	Adjusts the difference between the lightest and darkest parts of the image	0 ~ 100
SHARPNESS	Adjusts projected image sharpness	0 ~ 100
TINT	Adjusts the image color balance of red and green	0 ~ 100
COLOR	Adjust the color value	0 ~ 100
SOFT	Provide enhanced contrast and sharpness	
STANDARD	Provide standard contrast and sharpness	

COLOR MODE		VALUE
6500K	Give the white color a reddish tint	
NORMAL	Give the white color a neutral tint	
9000K	Give the white color a blue-ish tint	
USER 1 & 2	Apply user selected values - Red, Green & Blue	0 ~ 255

# CONTROL AND FUNCTION

## Image

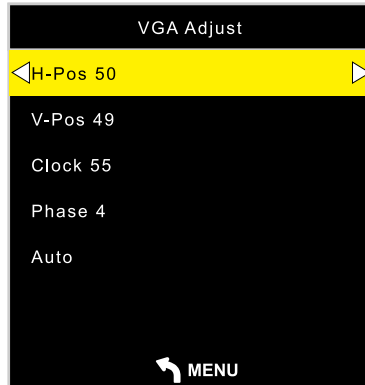
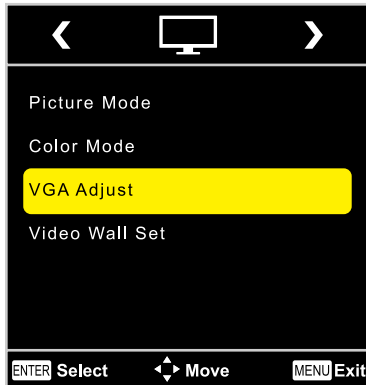

▲/▼ MOVE ◀/▶ ADJUST  
 ENTER SELECT MENU RETURN

FUNCTION		VALUE
H-POSITION <sup>1)</sup>	Adjust the horizontal picture position	1 ~ 100
V-POSITION <sup>1)</sup>	Adjust the vertical picture position	1 ~ 100
CLOCK <sup>1)</sup>	Adjust the number of horizontal picture elements	1 ~ 100
PHASE <sup>1)</sup>	Adjust the vertical noise of screen image	1 ~ 100
AUTO ADJUST	Adjust the screen automatically	Press <b>ENTER</b> button on remote controller to set auto adjust for screen

1) Only available in VGA input

# CONTROL AND FUNCTION

## Image

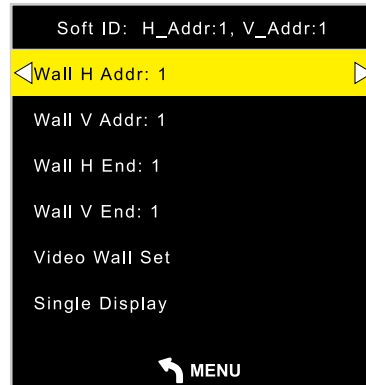
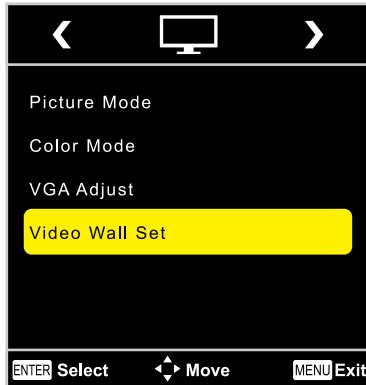

▲/▼ MOVE ◀/▶ ADJUST  
 ENTER SELECT MENU RETURN

FUNCTION		VALUE
Soft ID	Monitor's physical location <sup>1)</sup>	H_Addr: 1 ~ 15, V_Addr: 1 ~ 15
Wall H Addr	The horizontal starting number of video wall monitors	1 <sup>2)</sup>
Wall V Addr	The vertical starting number of video wall monitors	1 <sup>2)</sup>
Wall H End <sup>3)</sup>	The horizontal location value of video wall monitors	1 ~ 15
Wall V End <sup>4)</sup>	The vertical location value of video wall monitors	1 ~ 15
Video Wall Set	Switch selected/entire monitors as one of video wall system	
Single Display	Switch selected/entire monitors as only one display monitor	

1) 'H\_Addr:1 & V\_Addr:1' is the left-top monitor. This physical address is controlled by manual selection.

2) You can change the value of 'Wall H\_Addr & Wall V\_Addr' between 1 and 15. But the only available value is '1.'

3) You should select the horizontal location value between 1 and 15. The value '1' is assigned to the left-top corner monitor.

4) You should select the vertical location value between 1 and 15. The value '1' is assigned to the left-top corner monitor.

▶ To apply each monitor as one of the video wall system monitors, you should click 'Video Wall Set' after the setup of 'Wall H/V End'

▶ To apply all of video wall system monitors, you should apply 1) ~ 4) process to each monitor

# CONTROL AND FUNCTION

## Image - Video Wall Setup for HDCP

Generate ID	Identifier1: <input type="text" value="240"/>	Identifier2: <input type="text" value="240"/>
IR Control	H_Addr: <input type="text" value="1"/>	V_Addr: <input type="text" value="1"/>
Close OSD	Applications	
Identifier: 238-54 , Soft ID: ON, H_Addr:1, V_Addr:1		

Soft ID: H_Addr:1, V_Addr:1
◀ Wall H Addr: 1 ▶
Wall V Addr: 1
Wall H End: 1
Wall V End: 1
Video Wall Set
Single Display
↶ MENU

▲/▼ MOVE ◀/▶ ADJUST  
 ENTER SELECT MENU RETURN

	FUNCTION	VALUE
Generate ID	Creates the logical identification code (Identifier)	Variable
IR Control	Sees the horizontal and vertical address of selected monitor	
Close OSD	Close ID OSD window	
Identifier	The logical identification code created by 'Generate ID'	Variable
Soft ID	The Physical location address of video wall system monitors	H_Addr:1 ~ 15, V_Addr:1 ~ 15

- 1) Press the 'ID (0)' button on the remote controller
- 2) On the ID OSD window, select 'Generate ID' and click it to create the own logical identification code ('Identifier' on the left-bottom)
- 3) Based on the 'Identifier Code (**Identifier**)', type the code into the "Identifier 1 & Identifier 2"  
 On the above picture, '238' is the Identifier 1 and '54' is the Identifier 2.
- 4) If this monitor is located at 2nd row & 3rd column (for ex. 3x3 videowall), type '2' on **H\_Addr** and '3' on **V\_Addr**
- 5) Click '**Application**' to be applied typed values. Then, click '**Close OSD**'  
 ▶ After this process, if you open the 'ID' OSD window, it will show default value. But, the values (for HDCP input) is already set it up

# CONTROL AND FUNCTION

## Setup

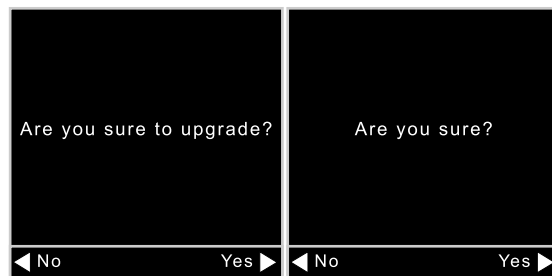
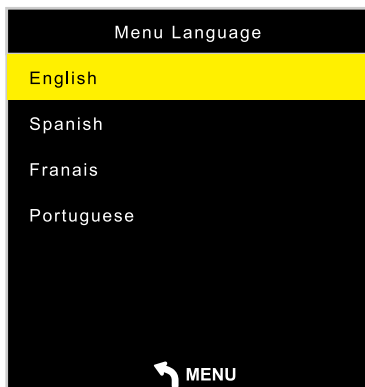
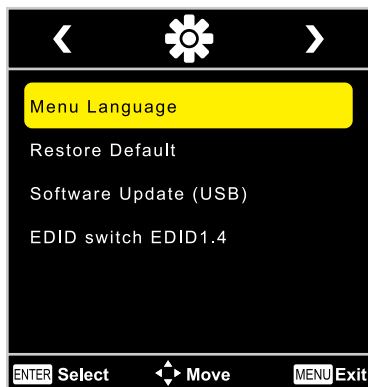

Update Firmware Software

Restore Default

▲/▼ MOVE ◀/▶ ADJUST  
 ENTER SELECT MENU RETURN

	FUNCTION	VALUE
MENU LANGUAGE	Set the language of the OSD menu	English/Spanish/French/ Portuguese
RESTORE DEFAULT	Reset the monitor settings to the factory default	YES/NO
SOFTWARE UPDATE <sup>1)</sup>	Update the monitor firmware by default	YES/NO
EDID SWITCH EDID 1.4	Change EDID version for HDCP Input	1.4/ 2.0

1) You can use USB drive to upgrade firmware of monitor.

# MOUNTING GUIDE

## Wall Mounting (Optional)

VZ-UNBS monitors are suitable for universal wall mount (not included).

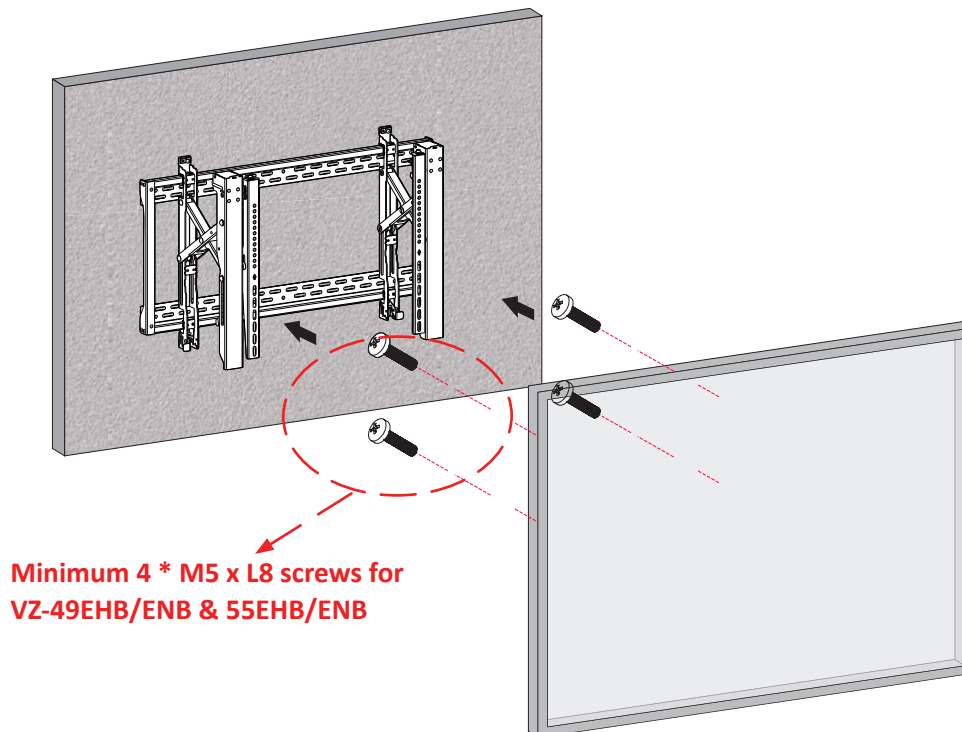

1. VZ-49ENB & VZ-49EHB : Universal WALL MOUNT 600 x 400 mm
2. VZ-55ENB & VZ-55EHB : Universal WALL MOUNT 707.1 x 410/450 mm mm

### ! WARNING !

If user uses screws bigger and longer than M6 x L12 mm for VZ-49UNBS & VZ-55UNBS it may cause damage to the unit. Please use bolt of correct size and length as instructed.

### ! Mounting Safety !

At least two people are recommended to safely install the mount and monitor.

# RS232 (RJ-45) PIN ASSIGNMENT

## PIN MAP

The following image is the description of RJ-45 PIN MAP

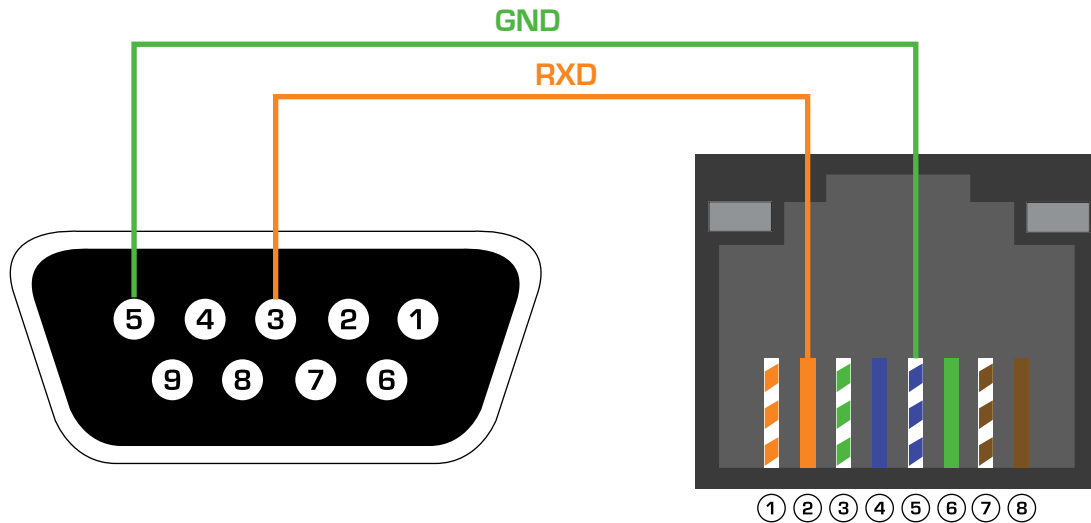

	RS232 (DP9)	RJ45
RXD (Received Data)	3	2
GND (Groud)	5	5

If your video wall system requires an unified control by the central control (do not use provided video wall screen control software), please use the provided RJ-45(RS-232) cables to configure the sytem. If necessary, you can make your own RJ-45(RS-232) cables based on the above pin map. If you have further questions, please contact ViewZ.

## Firmware Upgrade/Update Process

- Download or copy Firmware file from ViewZ.
- Copy the file to the empty USB
  - \*Caution - This file should be placed in the root folder of USB.**
- The software name is fixed as FLW\_V56, BIN file type.
  - Please note that the firmware file name should not be modified, otherwise the board cannot identify the firmware file.
- Turn off the monitor and insert the USB drive to the USB interface of monitor.
- Turn the power back on, then the monitor will be automatically upgraded/updated.
  - During the upgrade/update process, the power indicator will be flashing.
  - When the upgrade/update is completedm the power indicator will stop flashing.
- After the upgrade/update process, the monitor will relaunch, indicating the update/upgrade has been completed.
  - \*Caution - Do not turn off the power or remove the USB during upgrade/update process as the monitor board can be damaged in doing so.**

# SPECIFICATION

Model No.		VZ-49ENB	VZ-55ENB
Monitor Size		49"	55"
LCD	Panel Type	49" LED Backlit Monitor	55" LED Backlit Monitor
	Pixel Pitch (mm)	0.55926 (H) x 0.55926 (V) mm	0.630 (H) x 0.630 (V) mm
	Brightness	500 cd/m <sup>2</sup>	
	Contrast Ratio	3500 : 1	3500 : 1
	Viewing Angle	178° / 178°	
	Display Color	16.7 M	
	Response Time	< 8 ms (Gray to Gray)	
	Resolution	1920 (H) x 1080 (V)	
	Active Display Area	1073.78 (H) x 604 (V) mm	1209.6 (H) x 680.4 (V) mm
	Aspect Ratio	16 : 9	
Bezel width (T / B / L / R)		0.030" / 0.9 mm	0.030" / 0.9 mm
Active to Active Bezel		0.070" / 1.8 mm	0.070" / 1.8 mm
Case Type		Black Metal	
Color Temperature		Warm / Standard / Cool	
Operating Temperature		32 - 120°F / 0 - 50°C	
Storage Temperature		32 - 140°F / 0 - 60°C	
Operating Humidity		20 ~ 80% RH	
Weight		Net : 56.65 lbs / 25.69 kg Gross : 74.51 lb / 33.79 kg	Net : 61.83 lb / 28.05 kg Gross : 66.24 lb / 30.05 kg
INTERFACE		VIDEO(Composite) IN x 1, DP IN x 1, VGA (15Pin D-Sub) IN x 1 DVI IN x 1, HDMI IN x 1, USB IN x 1 RS 232 (RJ-45) IN x 1, RS 232 (RJ-45) OUT x 2	
Safety & EMC Certification		FCC / NDAA / RoHS	
Electrical Ratings		AC 100-240V, 50/60Hz	AC 100-240V, 50/60Hz
Power Consumption		≤ 120 W (Max) / 2 W (Standby)	≤ 180 W (Max) / 2 W (Standby)
Accessories		Manual x 1, Power Cable x 1, HDMI Cable x 1, CAT5 Cable x 1, Serial Adapter (RS232 to RJ45) x 1, Remote Control x 1, IR Receiver x 1	

# SPECIFICATION

Model No.		VZ-49EHB	VZ-55EHB
Monitor Size		49"	55"
LCD	Panel Type	49" LED Backlit Monitor	55" LED Backlit Monitor
	Pixel Pitch (mm)	0.55926 (H) x 0.55926 (V) mm	0.630 (H) x 0.630 (V) mm
	Brightness	800 cd/m <sup>2</sup>	700 cd/m <sup>2</sup>
	Contrast Ratio	3500 : 1	3500 : 1
	Viewing Angle	178° / 178°	
	Display Color	16.7 M	
	Response Time	< 8 ms (Gray to Gray)	
	Resolution	1920 (H) x 1080 (V)	
	Active Display Area	1073.78 (H) x 604 (V) mm	1209.6 (H) x 680.4 (V)
	Aspect Ratio	16 : 9	
Bezel width (T / B / L / R)		0.030" / 0.9 mm	0.030" / 0.9 mm
Active to Active Bezel		0.070" / 1.8 mm	0.070" / 1.8 mm
Case Type		Black Metal	
Color Temperature		Warm / Standard / Cool	
Operating Temperature		32 - 120°F / 0 - 50°C	
Storage Temperature		32 - 140°F / 0 - 60°C	
Operating Humidity		20 ~ 80% RH	
Weight		Net : 56.65 lbs / 25.69 kg Gross : 74.51 lb / 33.79 kg	Net : 61.83 lb / 28.05 kg Gross : 66.24 lb / 30.05 kg
INTERFACE		VIDEO(Composite) IN x 1, DP IN x 1, VGA (15Pin D-Sub) IN x 1 DVI IN x 1, HDMI IN x 1, USB IN x 1 RS 232 (RJ-45) IN x 1, RS 232 (RJ-45) OUT x 2	
Safety & EMC Certification		FCC / NDAA / RoHS	
Electrical Ratings		AC 100-240V, 50/60Hz	AC 100-240V, 50/60Hz
Power Consumption		≤ 120 W (Max) / 2 W (Standby)	≤ 180 W (Max) / 2 W (Standby)
Accessories		RS232 cable, AC 110V Power cable, User's Manual, Remote controller CAT5 Cable x 1, Serial Adapter (RS232 to RJ45) x 1, Remote Control x 1, IR Receiver x 1	

# TROUBLESHOOTING GUIDE

- Check the following before calling for service.
- If the same problems continue after checking, contact the reseller you purchased the monitor from.

At start	We recommend that you test with different input sources when you have trouble with the current input source. If symptom persists, follow the instructions below. After following the instructions below, please contact us at 1-888-99-VIEWZ.
No image or Noise on the screen	<ul style="list-style-type: none"> <li>- Make sure the cable is correctly plugged into the outlet.</li> <li>- Make sure the power cable is correctly plugged into the monitor.</li> <li>- Make sure the cable is correctly connected between monitor &amp; source.</li> <li>- Make sure to use RS-232/RJ-45 cable provided with the monitor</li> <li>- Check the RS-232/RJ-45 cable connection &amp; Daisy chain wiring configuration.</li> <li>- Check the brightness setting and see if brightness is set to 'Ø'.</li> <li>- Check the video source.</li> </ul>
Incorrect display or Half display	<ul style="list-style-type: none"> <li>- Check your video source</li> <li>- Reset video source : connection, cable replacement, setting &amp; more</li> </ul>
Flickering and shadow image	<ul style="list-style-type: none"> <li>- Check your input source setting for resolution and phase (Hz)</li> </ul>
The audio function is not working	<ul style="list-style-type: none"> <li>- Check the volume and make sure MUTE is not on</li> <li>- Check HDMI / BNC / Audio port cable connection</li> </ul>
LED is flickering or no image	<ul style="list-style-type: none"> <li>- Check the interface cable connection and make sure it's plugged in correctly</li> <li>- Check the input source</li> </ul>

# TERMS OF WARRANTY / RMA

- The warranty period for this monitor is 3 years. The warranty will be voided for the scenarios listed below.
- You can also download the manual and information on VIEWZ web site: VIEWZUSA.COM

Cases of Non-Warranty Coverage	When power feed to the monitor exceeds capacity and causes damage.
	Accident, Abuse, Misuse, Neglect, Fire, Water/liquids, Lightning or any act of nature.
	Damaged by dropping, throwing and hitting the monitor.
	Failure caused by user's attempt to modify the product.
	Failure by limited life of parts such as LED lamps and any other consumables.
	Damaged by using third party power cable, unstable power input and electric shock.

\* Above information can be changed without notification - please check our website or contact ViewZ representative for the latest RMA service policy.

\* When shipping the monitor for RMA, make sure to pack safely to ensure the monitor is not damaged during shipping.



# WARRANTY

## ViewZ USA LIMITED 3 YEAR WARRANTY

### What and Who is Covered by this Limited Warranty and for How Long

ViewZ USA warrants this product to be free from defects in material and workmanship for 3 years to the original owner of this product. The limited warranty is valid only for the original purchaser of the product.

### What ViewZ USA Will Do

At their sole discretion, ViewZ USA will repair or replace any product or product part that is defective. If ViewZ USA chooses to replace a defective product or part, a replacement product or part will be shipped to you at no charge, but you must pay any labor costs.

### What is Not Covered; Limitations

ViewZ USA disclaims any liability for damage to mounts, adapters, displays, projectors, other property, or personal injury resulting, in whole or in part, from improper installation, modification, use or misuse of its products.

ViewZ USA disclaims all other warranties, express or implied, including warranties of merchantability and fitness for a particular purpose. ViewZ USA is not responsible for incidental or consequential damages, including but not limited to, inability to use its products or labor costs for removing and replacing defective products or parts. Some states do not allow the exclusion or limitation of incidental or consequential damage, so the above limitation or exclusion may not apply to you.

### What Customers Must Do for Limited Warranty Service

If you discover a problem that you think may be covered by the warranty you MUST REPORT it in writing to the address below within thirty (30) days. Proof of purchase (an original sales receipt) from the original consumer purchaser must accompany all warranty claims. Warranty claims must also include a description of the problem, the purchaser's name, address, and telephone number. General inquiries can be addressed to ViewZ USA Customer Service at 1-888-998-4399. Warranty claims will not be accepted over the phone or by fax.

ViewZ USA  
Attn: Warranty Claim  
1030 N ARMANDO ST.,  
ANAHEIM, CA 92806

### How State Law Applies

This warranty gives you specific legal rights, and you may also have other rights which vary from state to state.

### Disclaimer

ViewZ USA intends to make this manual accurate and complete. However, ViewZ USA makes no claim that the information contained herein covers all details, conditions or variations, nor does it provide for every possible contingency in connection with the installation or use of this monitor. The information contained in this document is subject to change without notice or obligation of any kind. ViewZ USA makes no representation of warranty, expressed or implied, regarding the information contained herein. ViewZ USA assumes no responsibility for accuracy, completeness or sufficiency of the information contained in this document.

### Contact Us

**NORTH AMERICA**  
1030 N ARMANDO ST.,  
ANAHEIM, CA 92806  
USA and Canada  
Phone: 1-888-998-4399  
Fax: 1-714-996-1138  
Other Locations  
Phone: (001) 888-998-4399  
Fax: (001) 714-996-1138

© ViewZ USA