

# VZ-CM308

Telescopic Ceiling Mount with length, rotation and tilt adjust

---

## VZ-CM308 series INSTALLATION INSTRUCTIONS

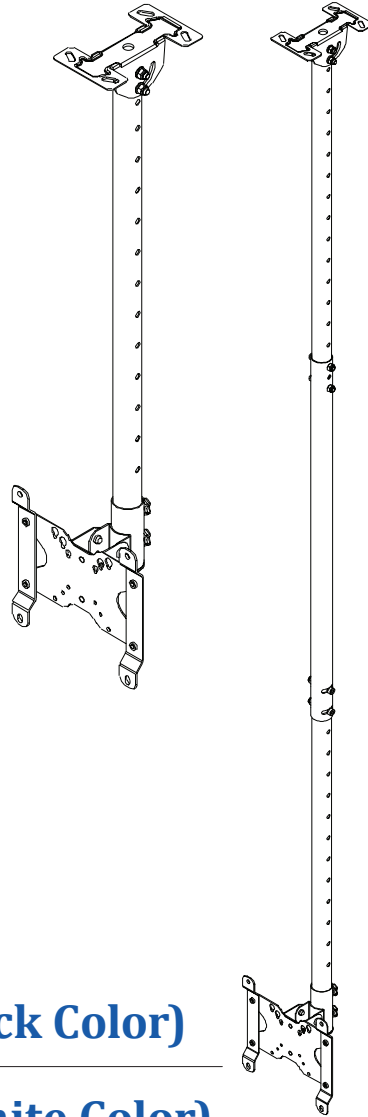

---

**VZ-CM308-B (for Black Color)**

---

**VZ-CM308-W (for White Color)**

---

**VZ-CM-EB (Optional Extension Pole set for Black Color)**

---

**VZ-CM-EW (Optional Extension Pole set for White Color)**

**ViewZ<sup>®</sup>**  
[www.viewzusa.com](http://www.viewzusa.com)













## Contents

Weight Limit .....	2
Warning Statements .....	2
Ceiling Mount info.....	3
Assembly Component List .....	3
Features .....	5
Installing the Mount .....	6
Leveling the Pole .....	7
Mounting Monitor-Bracket to Pole .....	7
Installing Monitor to the Pole .....	9
Warranty .....	10

## Weight Limit

Maximum Monitor Weight: **66.1 lbs**

## Warning Statements

-  PRIOR TO THE INSTALLATION OF THIS PRODUCT, THE INSTALLATION INSTRUCTIONS MUST BE READ AND COMPLETELY UNDERSTOOD. KEEP THESE INSTALLATION INSTRUCTIONS IN AN EASILY ACCESSIBLE LOCATION FOR FUTURE REFERENCE.
  -  PROPER INSTALLATION PROCEDURE BY A QUALIFIED SERVICE TECHNICIAN MUST BE FOLLOWED, AS OUTLINED IN THESE INSTALLATION INSTRUCTIONS. FAILURE TO DO SO COULD RESULT IN PROPERTY DAMAGE, SERIOUS PERSONAL INJURY, OR EVEN DEATH.
  -  SAFETY MEASURES MUST BE PRACTICED AT ALL TIMES DURING THE ASSEMBLY OF THIS PRODUCT. USE PROPER SAFETY EQUIPMENT AND TOOLS FOR THE ASSEMBLY PROCEDURE TO PREVENT PERSONAL INJURY.
  -  ViewZ USA DOES NOT WARRANT AGAINST DAMAGE CAUSED BY THE USE OF ANY ViewZ USA PRODUCT FOR PURPOSES OTHER THAN THOSE FOR WHICH IT WAS DESIGNED OR DAMAGE CAUSED BY UNAUTHORIZED ATTACHMENTS OR MODIFICATIONS, AND IS NOT RESPONSIBLE FOR ANY DAMAGES, CLAIMS, DEMANDS, SUITS, ACTIONS OR CAUSES OF ACTION OF WHATEVER KIND RESULTING FROM, ARISING OUT OF OR IN ANY MANNER RELATING TO ANY SUCH USE, ATTACHMENTS OR MODIFICATIONS.
  -  CHANGES OR MODIFICATIONS NOT EXPRESSLY APPROVED BY THE PARTY RESPONSIBLE FOR COMPLIANCE COULD VOID THE USERS AUTHORITY TO OPERATE THE EQUIPMENT.
  -  At least two qualified people should perform the assembly procedure. Personal injury and/or property damage can result from dropping or mishandling the flat-panel.
  -  If mounting to wall studs or ceiling studs, make sure that the mounting screws are anchored into the center of the wall studs or ceiling studs. Use of an edge-to-edge stud finder is recommended.
  -  Using replacement parts or accessories other than from the manufacturer may void the warranty.
  -  Be aware of the mounting environment. If drilling and/or cutting into the mounting surface, always make sure that there are no electrical wires in wall. Cutting or drilling into an electrical line may cause serious personal injury.
  -  Make sure there are no water or natural gas lines inside the wall where the mount is to be located. Cutting or drilling into a water or gas line may cause severe property damage or personal injury.
  -  This product is intended for indoor use only. Use of this product outdoors could lead to product failure and/or serious personal injury.
  -  Do not install near sources of high heat. Do not install on a structure that is prone to vibration, movement or chance of impact.
-  Contact ViewZ with any questions:  
(888) 998-4399  
techsupport@viewzusa.com

## Telescopic Ceiling Mount Info

This bracket is designed to mount a monitor from the ceiling structure. It can be used with the existing truss structure of the building or in conjunction with a channel strut. There are four lengths of brackets available.

- Part # VZ-CM308-B Length of 3' to 8'
- Part # VZ-CM308-W Length of 3' to 8'
- Part # VZ-CM-EW Length of 3' to 5.2' Optional Extension Pole Set
- Part # VZ-CM-EB Length of 3' to 5.2' Optional Extension Pole Set

## Installation Tools

The following tools may be required depending on your installation.

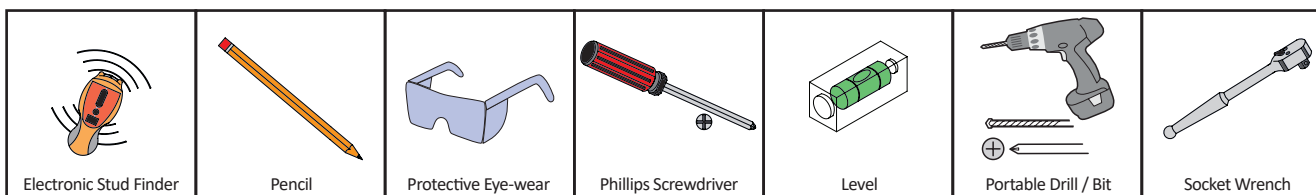

## Assembly Components

Your ViewZ mount product is shipped with all proper installation hardware and components. If there are parts missing and/or damaged, please stop the installation and contact ViewZ USA at (888)-998-4399.

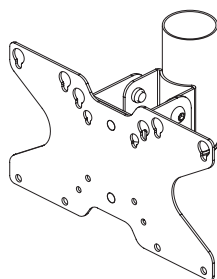

Monitor Hold Bracket (1 pc.)

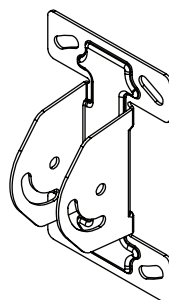

Wall/Ceiling Mount Bracket (1 pc.)

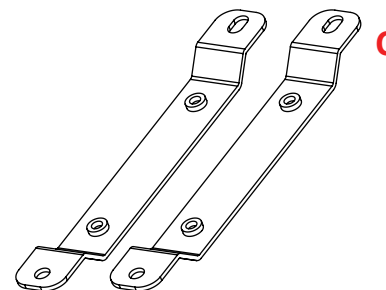

Monitor Hold Bracket (2 pc.)

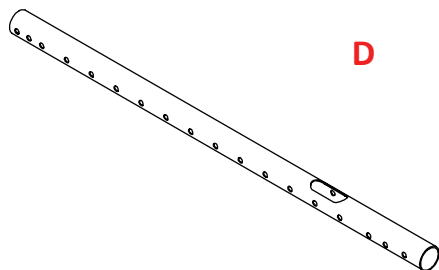

Top Pole (1 pc.)

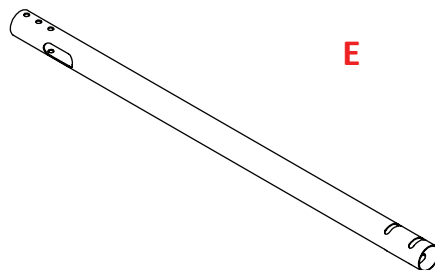



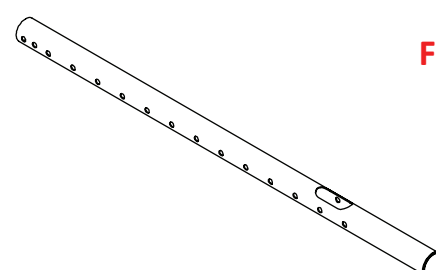





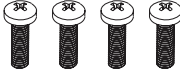
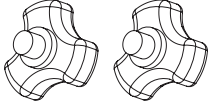
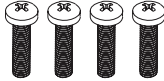
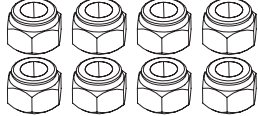
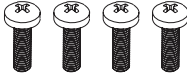

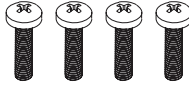
Middle Pole (1 pc.)

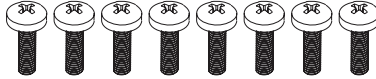

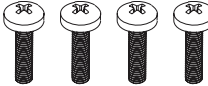
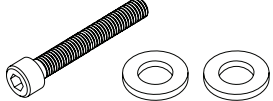
Bottom Pole (1 pc.)

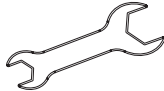
## Assembly Components (cont'd)

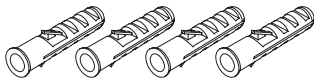
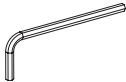
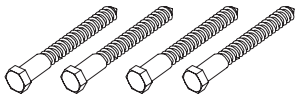
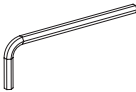
M4 x L12 mm Screw (Qty 4)		<b>G</b>	M6 x L8 mm Lock Screw (Qty 2)		<b>Q</b>
M4 x L15 mm Screw (Qty 4)		<b>H</b>	M8 Lock Nut (Qty 8)		<b>R</b>
M5 x L12 mm Screw (Qty 4)		<b>I</b>	M6 Washers (Qty 4)		<b>S</b>
M5 x L15 mm Screw (Qty 4)		<b>J</b>	M8 Washers (Qty 14)		<b>T</b>
M6 x L12 mm Screw (Qty 8)		<b>K</b>	M12 Lock Nut (Qty 1)		<b>U</b>
M6 x L15 mm Screw (Qty 4)		<b>L</b>	M12 x L100 Screw (Qty 1) M12 Washers (Qty 2)		<b>V</b>
M6 x L16 Hexangular Screw (Qty 4)		<b>M</b>	Open Wrench (13/19 mm) (Qty 1)		<b>W</b>
M8 x L55 Hexangular Screw (Qty 6)		<b>N</b>	6 mm Allen Wrench (Qty 1)		<b>X</b>
M8 x L50 Anchor (Qty 4)		<b>O</b>	8 mm Allen Wrench (Qty 1)		<b>Y</b>
M8 x L70 Self Tapping Hex Screws (Qty 4)		<b>P</b>	12 mm Allen Wrench (Qty 1)		<b>Z</b>

# Features

## Extension Pole Configuration / Tilt, Swivel

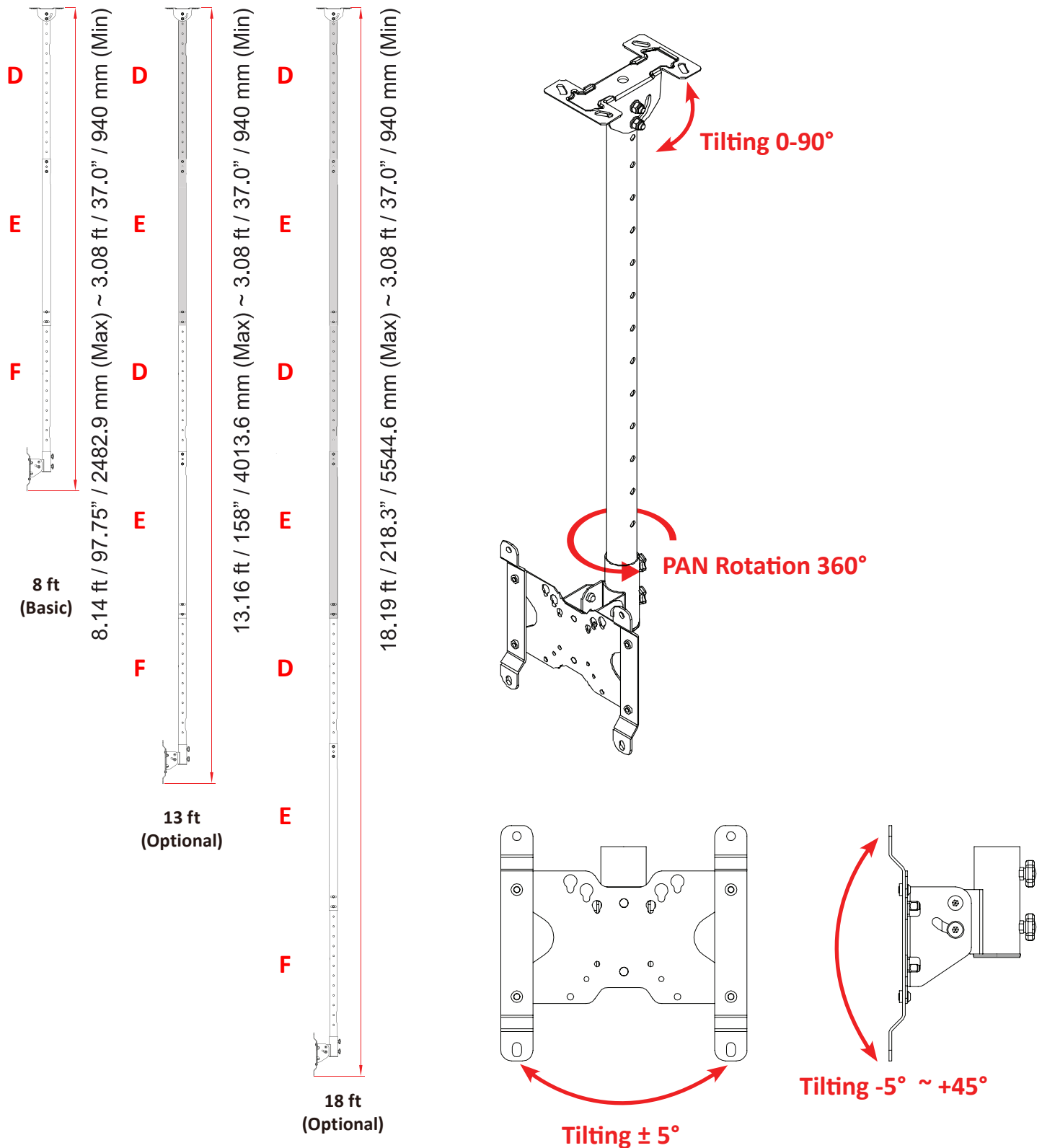

## Installation

### Securing Mount to Building

- 1) Mount Wall/Ceiling mount bracket (B) with screw & washers (V)
- 2) Tighten the M12 (U) lock nut using a open-wrench

- 3) Insert screw to Wall/Ceiling mount bracket with washers when you setup the position of top pole.
- 4) You can adjust pole angle between 0° and 90°.
- 5) Tighten the M8 lock nut using a open-wrench.

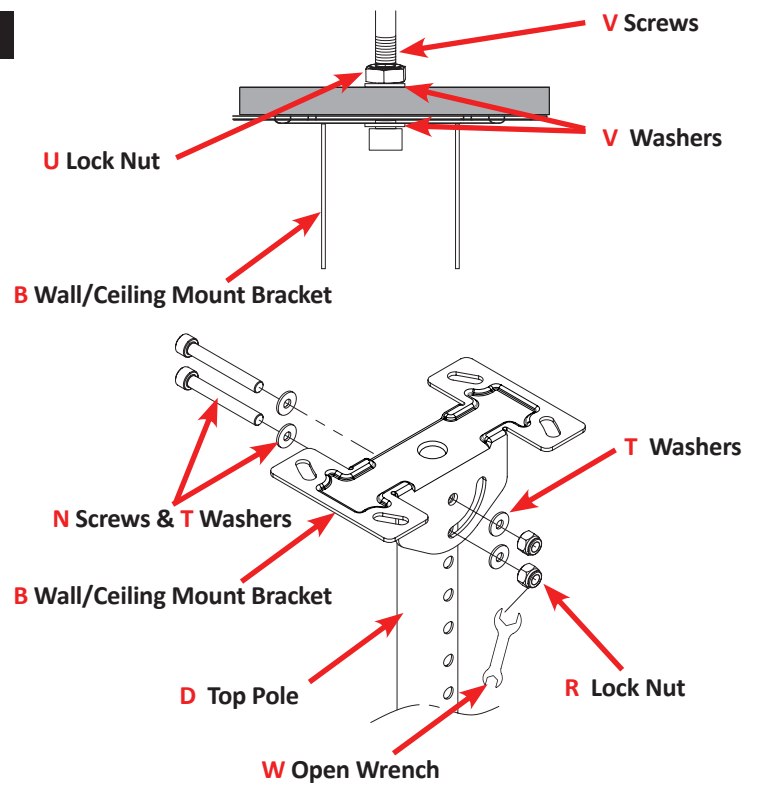

### Secure Mounting to Brick/Concrete or Wood

#### Brick or Concrete Wall/Ceiling Mounting

- 1) Insert anchors to truss or channel strut (brick, concrete or wood)
- 2) Insert screw to Wall/Ceiling mount bracket with washers rod between truss gap or hole in channel strut.
- 3) Place washer over the threaded rod and then tighten using wrench.

#### Wood Mounting

- 1) Insert screw to Wall/Ceiling mount bracket between truss gap or hole in channel strut.



**Caution:** Please be extra cautious when finding a mountable position in the ceiling. Dry-wall or weak-wood material cannot bear the weight of pole & monitor.

#### Brick or Concrete

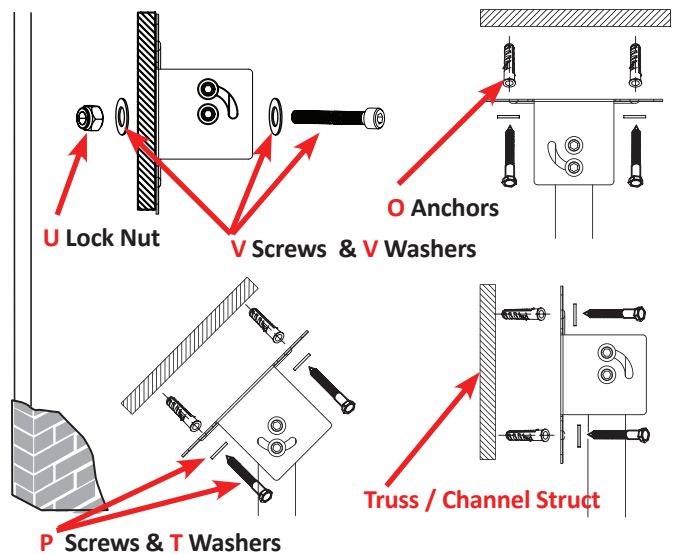

#### Wood

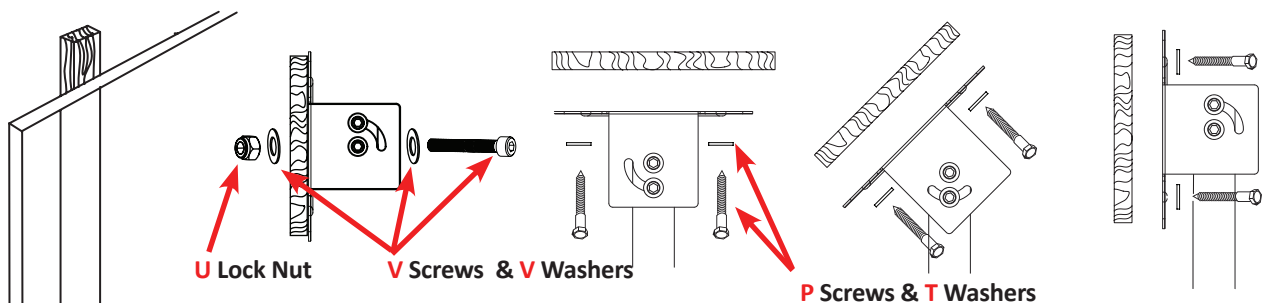

## Installation

### Leveling the Pole (Top & Middle)

- 1) You can ensure the pole is properly aligned by tightening the lock screws/nuts between top & middle, middle & bottom poles.
- 2) Place a level on poles (top & bottom) and tighten the screws/nuts (see illustration on the right).
- 3) Check and adjust 2 adjacent sides of the pole until it is plumb in each direction.

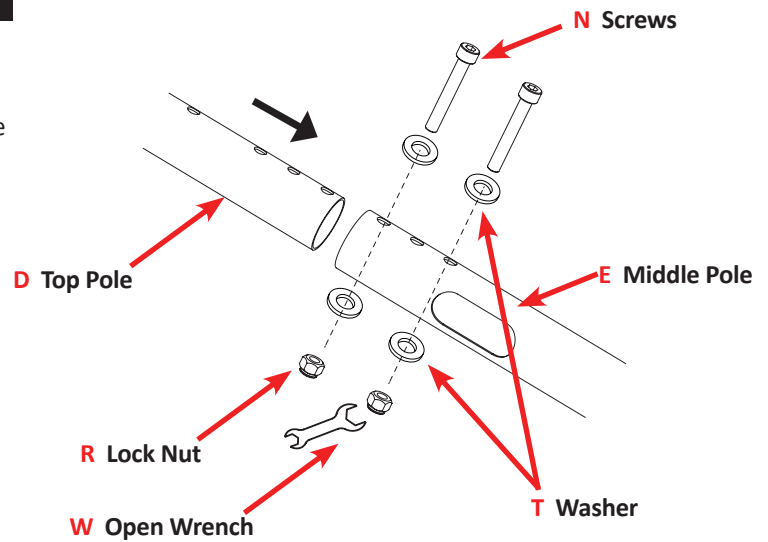

### Mounting Monitor-Hold-Bracket(Vesa Plate) to Pole

- 1) Hold the bottom pole and put 1-3/4" washer between vesa bracket and bottom pole (see illustration on the right).
- 2) Gently push the vesa bracket to bottom pole. Vesa bracket is bigger than bottom pole circumference.
- 3) You can rotate vesa plate before locking. If you have a desired direction for the plate, please rotate vesa bracket.
- 4) After setting the position, use M6xL8 lock screws and lock the vesa plate.

**\*NOTE: Avoid over-tightening which can cause the pole to cave.**

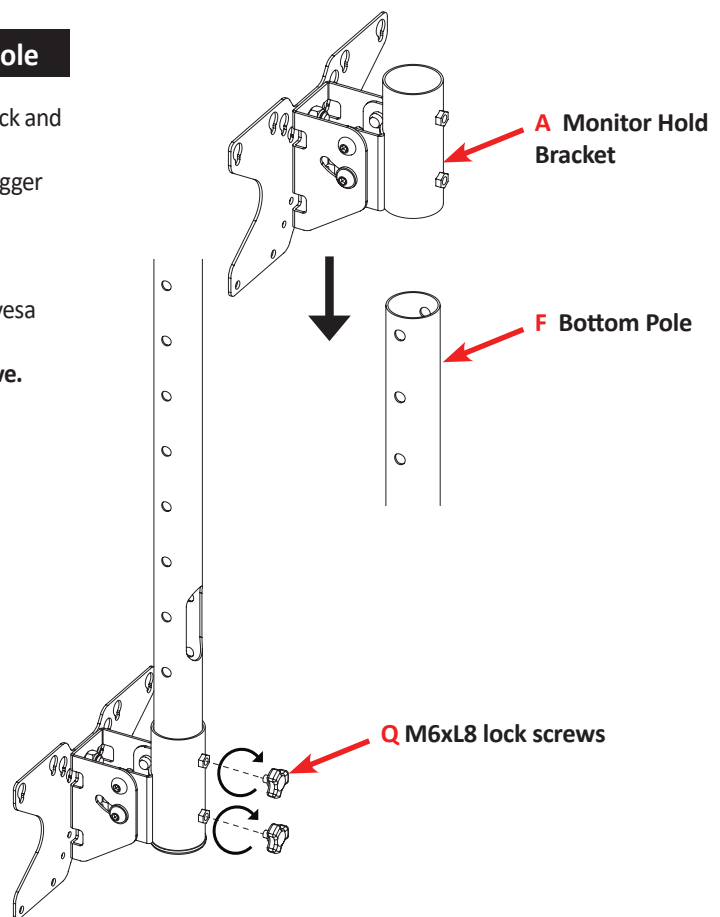

## Installation

### Leveling Pole (Bottom & Middle)

- 1) You can ensure the pole is properly aligned by tightening the lock screws/nuts between middle & bottom poles.
- 2) Place a level on poles (middle & bottom) and tighten the screws/nuts (see illustration on the right).
- 3) Check and adjust 2 adjacent sides of the pole until it is plumb in each direction.

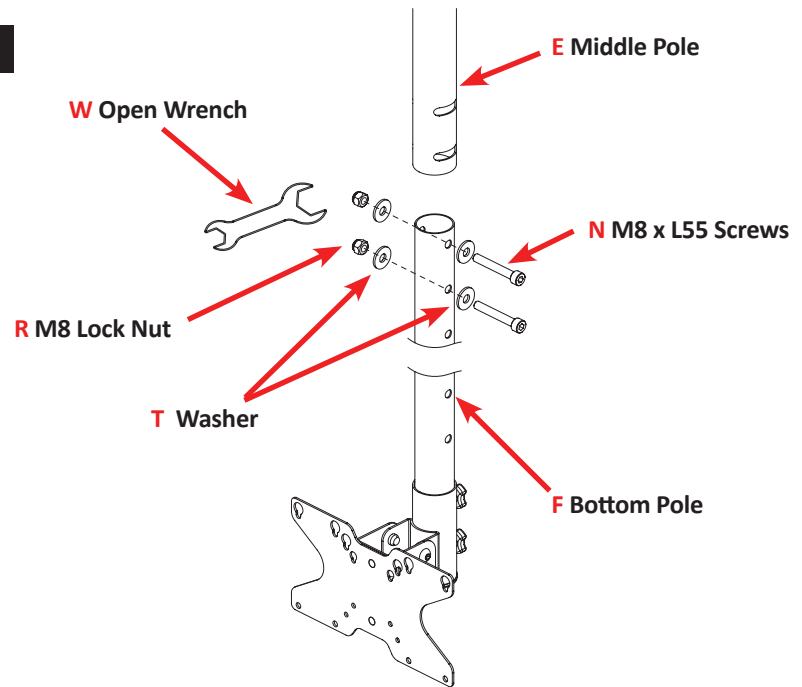

### Rotation

- 1) Hold the lower pole (where it connects to the monitor) and turn two lock screws counter-clockwise to loosen the VESA plate (see illustration on left below). Then, rotate vesa plate to set the position.
- 2) Once set in a desired position, lock the two lock-screws by turning clockwise.

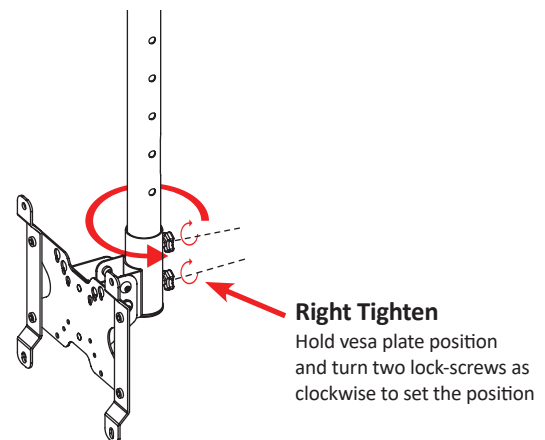
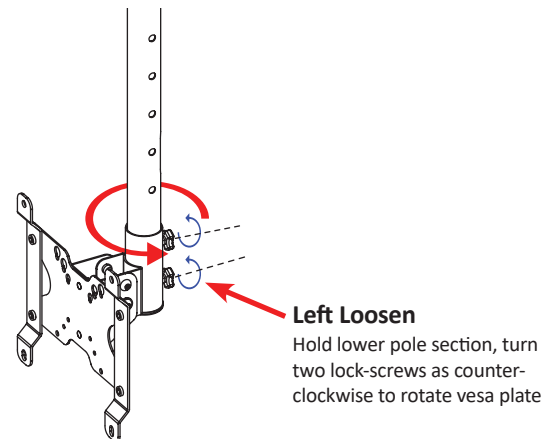



## Installation

### Direct Installation

- 1) Applicable VESA pattern - 50 x 50, 75 x 75, 100 x 100, 200 x 100  
If your monitor supports a VESA plate already mounted on the back, simply ensure the four M4/M5/M6 screws are in place and tightened. If the mount is not already attached, connect it using the supplied M4/M5/M6 VESA screws (4-places).

**Caution:** Some installations may require running power and video cables prior to attaching the monitor bracket to the pole. If this is the case, do so before continuing to step 2.

**Caution:** Some monitors require specific length of screws. Please check the affordable screw length before installing.

- 2) Install the M4 x L15 mm screw, washers, and monitor-hold bracket (if necessary) into the upper slotted hole according to the illustration on the right. You will need to use Phillips screwdriver or mobile screwdriver to fully tighten in the next step.
- 3) Tighten the fasteners to secure the monitor at the desired angle.  
**\*NOTE: Avoid over-tightening which can cause monitor damage**

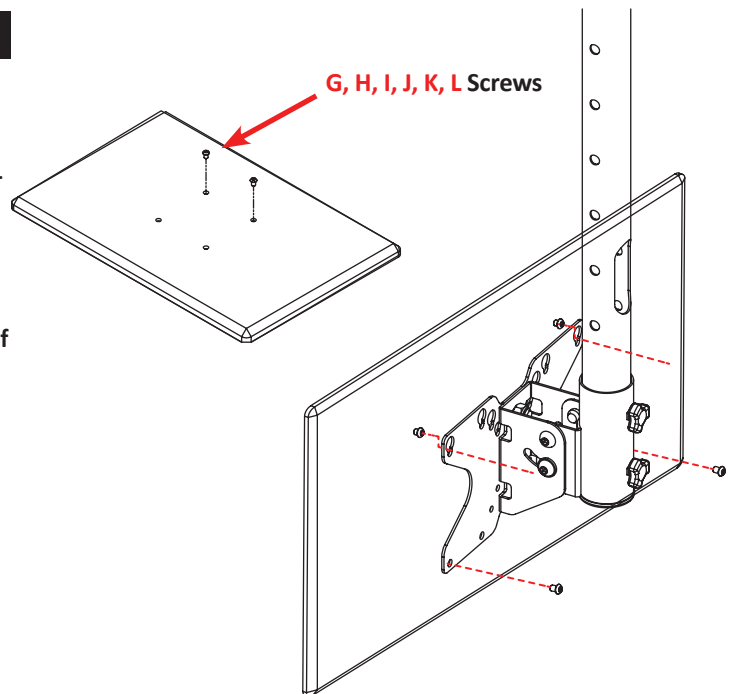

### Monitor Hold Bracket Installation

- 1) Applicable VESA pattern - 200 x 100, 200 x 200  
(Optional 400 x 400 available)

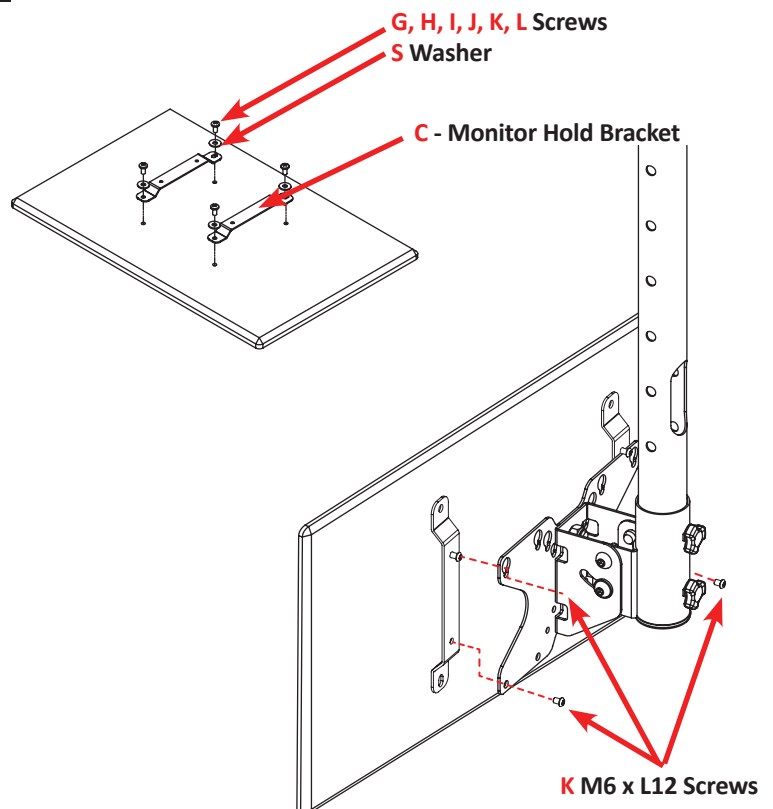

**Max Load:**  
**66.1 lbs / 30.0 kg**

**Caution:** This stand is intended for use only with products that are lighter than maximum weight indicated. Usage with products heavier than the maximum weight indicated may result in instability causing possible injury. This product is intended to mount to a steel support truss, or channel strut (Brick, Concrete or Wood)

## Warranty

### ViewZ USA LIMITED WARRANTY

#### What and Who is Covered by this Limited Warranty and for How Long

ViewZ USA warrants this product to be free from defects in material and workmanship of the original owner of this product. The limited warranty is valid only for the original purchaser of the product.

#### What ViewZ USA Will Do

At the sole option of ViewZ USA, ViewZ USA will repair or replace any product or product part that is defective. If ViewZ USA chooses to replace a defective product or part, a replacement product or part will be shipped to you at no charge, but you must pay any labor costs.

#### What is Not Covered; Limitations

ViewZ USA DISCLAIMS ANY LIABILITY FOR DAMAGE TO MOUNTS, ADAPTERS, DISPLAYS, PROJECTORS, OTHER PROPERTY, OR PERSONAL INJURY RESULTING, IN WHOLE OR IN PART, FROM IMPROPER INSTALLATION, MODIFICATION, USE OR MISUSE OF ITS PRODUCTS.

ViewZ USA DISCLAIMS ALL OTHER WARRANTIES, EXPRESS OR IMPLIED, INCLUDING WARRANTIES OF MERCHANTABILITY AND FITNESS FOR A PARTICULAR PURPOSE. ViewZ USA IS NOT RESPONSIBLE FOR INCIDENTAL OR CONSEQUENTIAL DAMAGES, INCLUDING BUT NOT LIMITED TO, INABILITY TO USE ITS PRODUCTS OR LABOR COSTS FOR REMOVING AND REPLACING DEFECTIVE PRODUCTS OR PARTS. SOME STATES DO NOT ALLOW THE EXCLUSION OR LIMITATION OF INCIDENTAL OR CONSEQUENTIAL DAMAGES, SO THE ABOVE LIMITATION OR EXCLUSION MAY NOT APPLY TO YOU.

#### What Customers Must Do for Limited Warranty Service

If you discover a problem that you think may be covered by the warranty you MUST REPORT it in writing to the address below within thirty (30) days. Proof of purchase (an original sales receipt) from the original consumer purchaser must accompany all warranty claims. Warranty claims must also include a description of the problem, the purchaser's name, address, and telephone number. General inquiries can be addressed to ViewZ USA Customer Service at 1-888-998-4399. Warranty claims will not be accepted over the phone or by fax.

ViewZ USA  
Attn: Warranty Claim  
177 W. Orangethorpe Ave.  
Placentia, CA 92870

#### How State Law Applies

THIS WARRANTY GIVES YOU SPECIFIC LEGAL RIGHTS, AND YOU MAY ALSO HAVE OTHER RIGHTS WHICH VARY FROM STATE TO STATE.

## Disclaimer

ViewZ USA intends to make this manual accurate and complete. However, ViewZ USA makes no claim that the information contained herein covers all details, conditions or variations, nor does it provide for every possible contingency in connection with the installation or use of this product. The information contained in this document is subject to change without notice or obligation of any kind. ViewZ USA makes no representation of warranty, expressed or implied, regarding the information contained herein. ViewZ USA assumes no responsibility for accuracy, completeness or sufficiency of the information contained in this document.

## Contact Us

#### NORTH AMERICA

177 W. Orangethorpe Ave.  
Placentia, CA 92870

USA and Canada

Phone: 1-888-998-4399

Fax: 1-714-996-1138

Other Locations

Phone: (001) 888-998-4399

Fax: (001) 714-996-1138

© ViewZ USA