

VZ-CGM SERIES

27" CURVED CCTV

LED MONITOR USER MANUAL



ViewZ[®]
www.viewzusa.com

Please read this manual thoroughly before use, and keep it handy for future reference.

CONTENTS

Safety Instruction	3
1. Mark Indication & Substance	4
2. Warning & Caution	4
3. FCC RF INTERFERENCE STATEMENT	6
Installation	7
1 Features	8
2. Stand Installation	9
3. Interface, Resolution & Refresh Rate	10
Function	11
1. Monitor Control Function	11
2. OSD Control and Function	12
Specification	19
Trouble Shooting	20
RMA	21
Warranty	23

SAFETY INSTRUCTIONS

Important Safety Instructions

1. **Read all warnings.**
2. Follow all instructions to ensure longevity of monitor.
3. Do not place the monitor near water.
4. Clean only with dry cloth.
5. Do not block any ventilation openings. Install in accordance with the manufacturer's instructions.
6. Do not install near any heat sources such as radiators, heat registers, stoves, or other heat generating devices.
7. Do not override the safety purpose of the polarized or grounding-type plug.
8. A polarized plug has two blades with one wider than the other.
9. A grounding type plug has two blades and a third grounding prong.
10. The wide blade or the third prong is provided for your safety.
11. If the provided plug does not fit into your outlet, consult with electrician for replacement of the outlet.
12. Protect the power cord from being walked on or pinched particularly at plugs, convenience receptacles and the point where it connects to the monitor.
13. Only use attachment/accessories specified by the manufacturer.
14. Use only with the cart, stand, tripod, bracket or table specified by the manufacturer or sold with the monitor. When a cart is used, use caution when moving the cart & monitor in combination to avoid injuries.
15. Unplug the monitor during lightning storms or when unused for long periods of time.
16. Refer all servicing to qualified service personnel. Servicing is required when the monitor has been damaged in any way.



The monitor shall not be exposed to dripping or splashing and objects containing liquids such as vases shall be placed near the monitor.

The monitor should have ample distance (e.g. 10cm) from the wall for sufficient ventilation.

SAFETY INSTRUCTIONS

Important Safety Instructions

Mark Indication and Substance



CAUTION : TO REDUCE THE RISK OF ELECTRICAL SHOCK,
DO NOT REMOVE COVER (OR BACK). NO USER
SERVICEABLE PARTS INSIDE. REFER SERVICING TO
QUALIFIED SERVICE PERSONNEL



This symbol is intended to alert the user to the presence of uninsulated & dangerous voltage within the monitor's enclosure that may be of sufficient magnitude to constitute a risk of electric shock to persons.



This symbol is intended to alert the user to the presence of important operating and maintenance (servicing) instructions in the literature accompanying the monitor.

Warning

- Do not use damaged or loose cables and plug.
- Do not pull the plug out by the wire nor touch the plug with wet hands.
- Use only a properly grounded plug and receptacle.
- Do not connect too many extension cords or plugs to one outlet.
- Do not excessively bend the plug and wire.
- Do not disconnect the power cord while it's still plugged into the monitor.
- Do not place any heavy objects on the power cord. Damage to the cord may cause shock or fire.
- Never open the monitor. There are no user-serviceable parts inside and opening will void warranty.
- Removing covers may expose you to dangerous shock hazards or other risks.
- Keep any heating devices away from the power cable and monitor.
- Do not place the monitor near water.
- Do not insert objects of any kind into the monitor's open slots, as they may touch dangerous voltage points.
- Please follow the laws and regulations of your municipality to dispose the monitor properly.
- Do not use the monitor in high temperature, humid, dusty or oily areas.
- Do not install the monitor where it will be exposed to continual vibration.
- Keep the plastic packaging out of children's reach.
- If any damage is detected upon first opening the box, contact agency from which you bought the monitor directly.
- If your monitor does not operate normally – in particular, if there is any unusual sound or smell coming from the monitor – unplug it immediately and contact an authorized dealer or the service center.

SAFETY INSTRUCTIONS

Important Safety Instructions

Caution

- If the connector between the plug and the pin is dusty or dirty, clean it properly using a dry cloth.
- Make sure to unplug the power cord before cleaning the monitor.
- Make sure to leave a gap between monitor and wall.
- Do not drop the monitor when moving it.
- Place your monitor in a location with low humidity and minimal dust.
- Install the monitor base on a showcase or shelf so that the end of the base does not protrude from the showcase or shelf.
- Do not place the monitor on an unstable or small surface area.
- Do not install inside a vehicle.
- Disconnect the plug from the outlet during storms or lightning or if it has not been used for a long time.
- Do not try to move the monitor by pulling on the power cord.
- Do not cover the vents on the monitor.
- When moving the monitor, turn off and unplug the power cord. Make sure that all cables, including HDMI cable and cables connected to other devices, are disconnected before moving it.
- Place the monitor out of children's reach as they could damage it by hanging onto it.

Available Temperature & Humidity

- Operating Temperature : 32°F ~ 122°F / 0°C ~ 50°C
- Operating Humidity : 5 ~ 90% RH

Dot Defect (dead pixel) of TFT

ViewZ monitors are manufactured using high-end semiconductor technology with precision ratings of 99.9% and above. However, it may be the case that certain RGB and white pixels seem darker (or entirely unlit i.e. black).

Modern production methods cannot guarantee an absolute fault-free monitor. To this effect, no LED manufacturer can guarantee a defect free panel. A few isolated pixel or sub-pixel faults are considered tolerable and different policies exist that govern the amount of these tolerable values.

While most pixel faults occur in isolated regions, a cluster of dead pixels or sub-pixels can sometimes form for which a separate ruling applies. A cluster is defined as an area of 5x5 pixels. ViewZ's policy on pixel failure: either as an isolated fault or in the form of a cluster is outlined on the website: www.viewzusa.com

FCC RF INTERFERENCE STATEMENT

Note

This equipment has been tested and found to comply with the limits for a Class A digital device, pursuant to part 15 of the FCC Rules. These limits are designed to provide reasonable protection against harmful interference when the equipment is operated in a commercial environment.

This equipment generates, uses, and can radiate radio frequency energy and, if not installed and used in accordance with the instruction manual, may cause harmful interference to radio communications. Operation of this equipment in a residential area is likely to cause harmful interference in which case the user will be required to correct the interference at his own expense.

- Reorient or relocate the receiving antenna.
- Increase the separation between the equipment and receiver.
- Connect the equipment into an outlet on a circuit different from that to which the receiver is connected.
- Consult the dealer or an experienced radio, TV technician for help.
- Only shielded interface cable should be used.

Finally, any changes or modifications to the equipment by the user not expressly approved by the grantee or manufacturer could void the users authority to operate such equipment.

► DOC COMPLIANCE NOTICE

This digital apparatus does not exceed the Class A limits for radio noise emissions from digital apparatus set out in the radio interference regulation of Canadian Department of communications.

Statement

- VGA and XGA are the registered trademark of IBM.
- VESA is the trademark of Video Electronics Standard Association.
- HDMI, HDMI logo and High-Definition Multimedia Interface (high definition multimedia digital interface) are the trademark or registered trademark of HDMI Licensing LLC.

If some company or product trademark is not particularly stated, the use of trademark has been fully recognized. Do not alter, decompile, disassemble, decode or conduct reverse engineering to the software installed in the product, or it can be deemed as breach of the law.

INSTALLATION

Installation Tools

The following tools may be required or recommended.

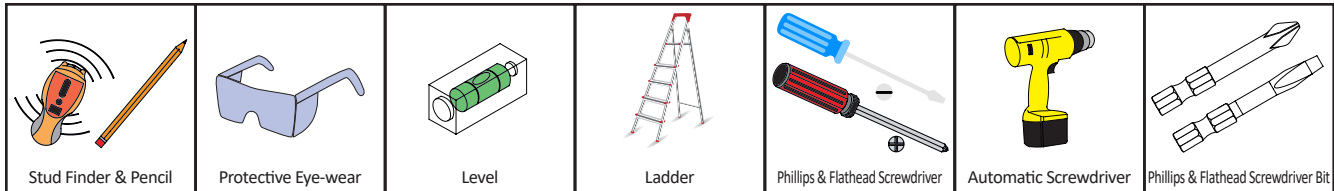

Assembly Components - provided

Your ViewZ monitor is shipped with all proper installation hardware and components. If there are parts missing and/or damaged, please stop the installation and contact ViewZ USA at (888)-998-4399.

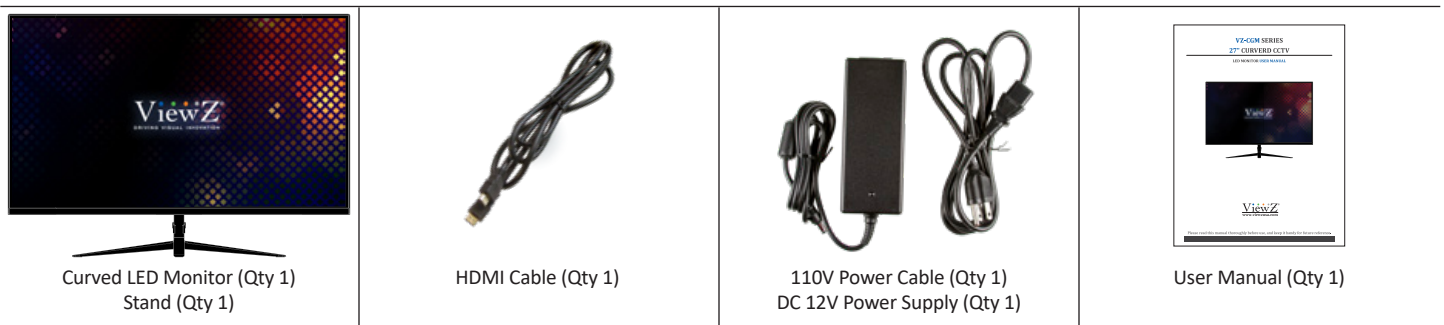



Mounting Options

Your ViewZ monitor is compatible with ViewZ monitor mounts. For more information, please contact ViewZ USA at (888)-998-4399.

Wall Mount

- | | | |
|--|---|---|
| <ul style="list-style-type: none"> Part # VZ-WM05 • VESA 75, 100 • 15mm Low Profile  | <ul style="list-style-type: none"> Part # VZ-WM11 • Tilting -30° ~ 30° • Max. Weight 22 lb • Swivel 90°  | <ul style="list-style-type: none"> Part # VZ-AM02-A • Tilting -5° ~ 12° • Max. Weight 44lb • Swivel 180° • VESA 75 ~ 200  |
|--|---|---|

Ceiling Mount

- | | |
|--|---|
| <ul style="list-style-type: none"> Part # CMKIT-02 • Tilting -12° ~ +5° • Max. Weight 110 lb • VESA 75 ~ 200  | <ul style="list-style-type: none"> Part # CM-308 • Tilting -5° ~ 45° • Max. Weight 66 lb • Rotation 360° • Poll : 3 ~ 18 ft • Black / White  |
|--|---|

FEATURES

Features

- 1500R Curved display screen
- Designed for 24/7 operation
- 1ms response time
- User-friendly operation
- Supports Full HD resolution @ 1920 x 1080
- Supports DDC/CI (command)
- Supports MPRT (moving picture response time) feature
- Supports advanced DCR (dynamic contrast ratio) feature
- Supports adaptive sync
- Supports blue light filter
- Supports VESA

Description

- You are not allowed to copy, use, alter or disseminate this manual in whole or in part without prior written consent.
- Any and all product names, model names, labels, or company names used in this manual are the trademarks and registered trademarks of ViewZ.
- If you have any advice or question related to this manual, please contact our dealer, re-seller or our customer service representatives.

STAND INSTALLATION

Stand Installation

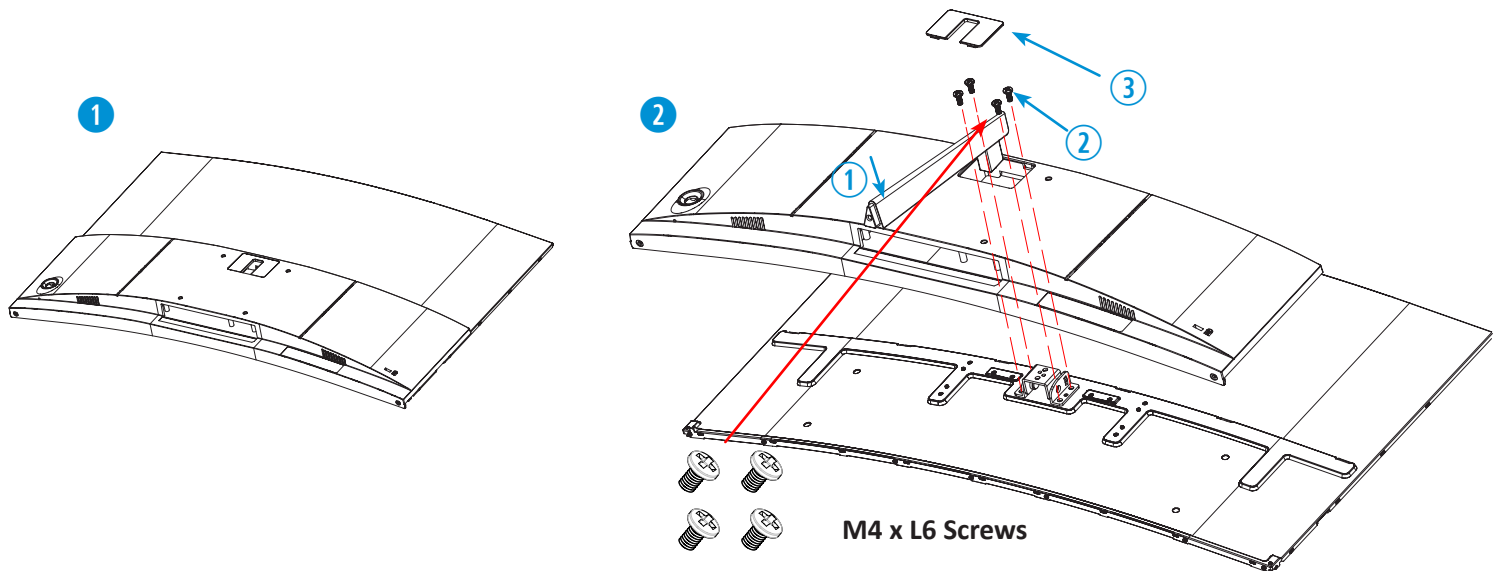

1. Put the monitor on the safe & soft place. Please be careful about the panel.
2. Put the stand bar and screw the 4 bolts (M4 x L6). Install the cover.
3. Install the base mount and screw a bolt (M4 x L14).

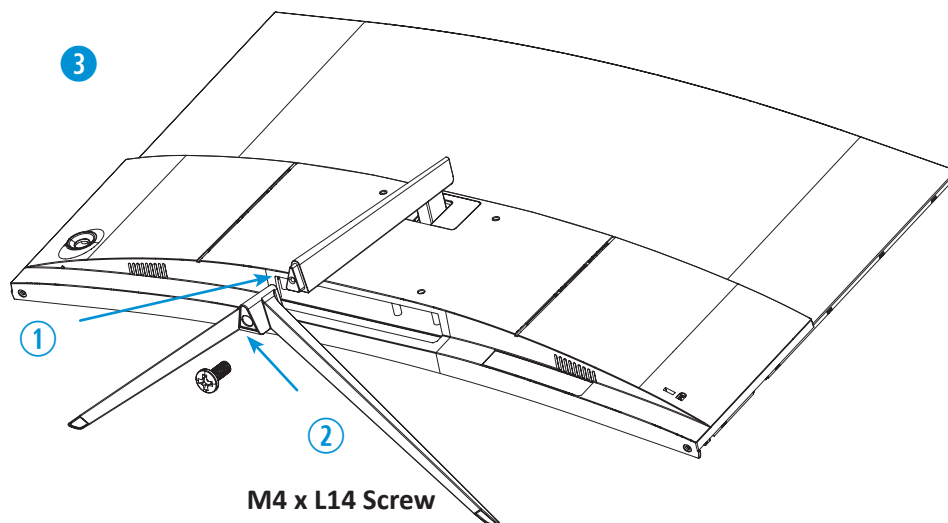

! **Attention!** Wall mount (VESA 100x100) allows you to mount this monitor on the wall. The wall mount bracket is not included and if you want to install the monitor on the wall, refer page 7 or contact to ViewZ (1-714-996-1177).



Mounting Safety !

At least two people are recommended to install the mount.

CONNECT EXTERNAL EQUIPMENTS

Interface Input Ports

The following image is the description of interface input ports

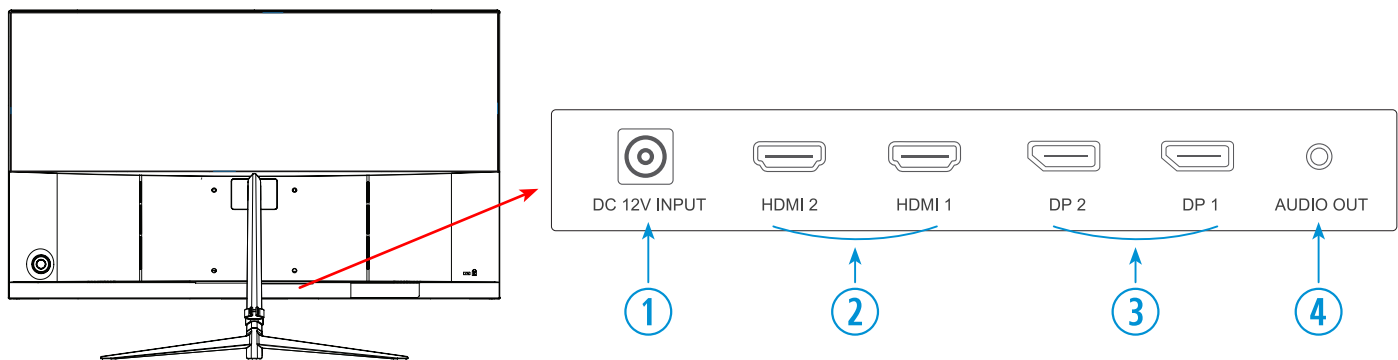

1. DC 12V
2. HDMI IN x2
3. DP IN x2
4. AUDIO OUT

Interface Resolution & Refresh Rate

Interface Input Source	Max Display Resolution	Refresh Rate
Display Port	1920 x 1080	240Hz
HDMI (2.0) In	1920 x 1080	240Hz

CONTROL AND FUNCTION

On Monitor, Button Control

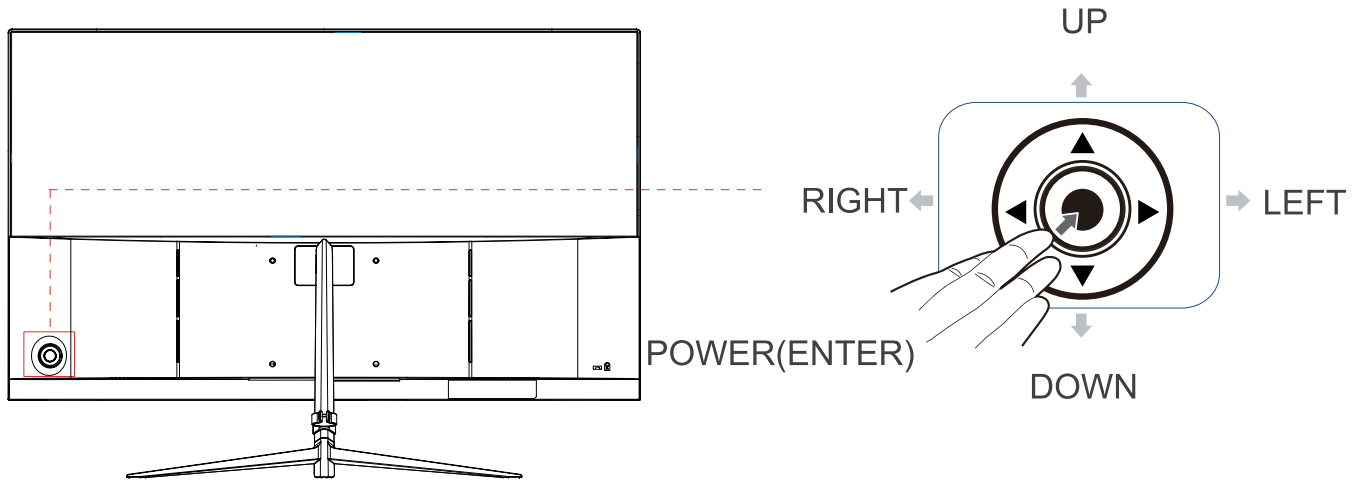

Monitor Button Function - No Menu Popup

The button is located on the rear left side of the monitor:

1. Press the **'POWER(ENTER)'** button and hold for 3 seconds to power off.
2. Press the ▲ button to change the aspect ratio.
3. Press the ▼ button to do nothing
4. Press the ◀ / ▶ buttons to adjust volume control

Monitor Button Function - Menu Popup

Display image, sound and custom settings can be adjusted in OSD (On Screen Display) menu by remote controller. To adjust monitor setting value:



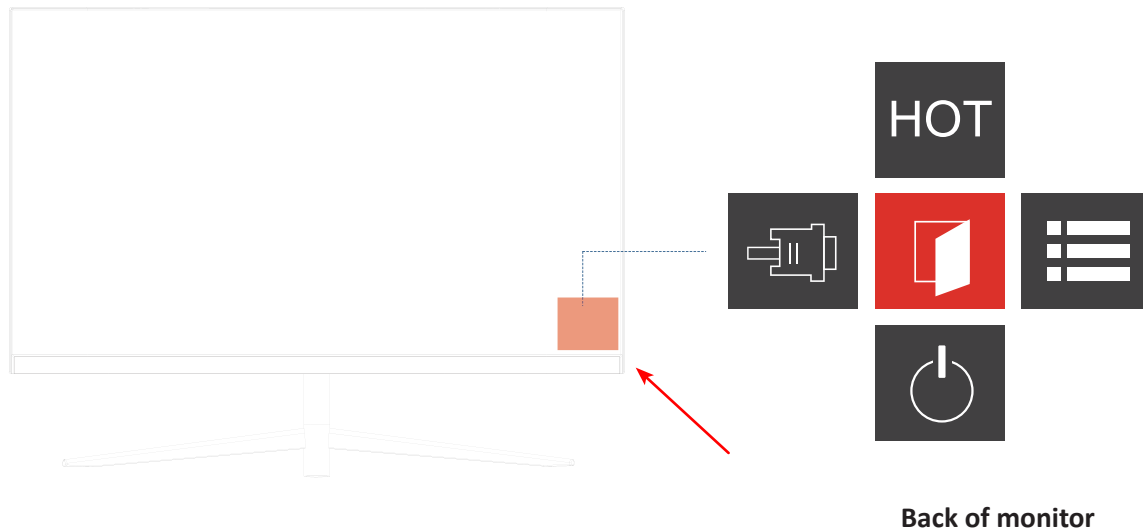

1. Press the **'POWER(ENTER)'** button to enter the OSD menu.
2. Press the **'POWER(ENTER)'** button to confirm / exit for saving adjustment value on **sub-MENU**.
3. Press the ▲ / ▼ buttons to select the desired **sub-MENU**.
4. Press the ◀ / ▶ buttons to change the value you wish to adjust.
5. Press the ▶ button to exit **sub-MENU** without saving value and go back to the previous menu.
6. Press the ◀ button to enter **sub-MENU**. The selected **sub-MENU** is highlighted

CONTROL AND FUNCTION

OSD



Press '**POWER(ENTER)**' button on monitor and then the OSD guide will popup. To access the OSD, press the corresponding direction button on the back of monitor.

-  Select this by using the direction button and press '**POWER(ENTER)**' button to enable / disable ECO mode.
-  Select this by using the direction button and press '**POWER(ENTER)**' button to switch the input source.
-  Select this by using the direction button and press '**POWER(ENTER)**' button to enter the main OSD.
-  Select this by using the direction button and press '**POWER(ENTER)**' button to turn off the monitor.

Select Input Source

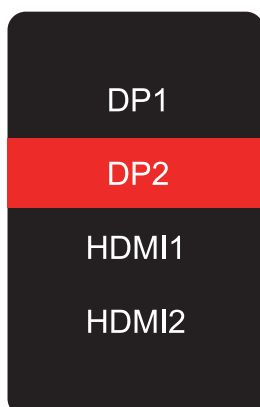

Press 'SOURCE' button on the above OSD.

Press ▲ / ▼ button to change input source and then press '**POWER(ENTER)**' button to select input source.

If you connect any input source, monitor will display current input source resolution and frequency.

CONTROL AND FUNCTION

Input Source

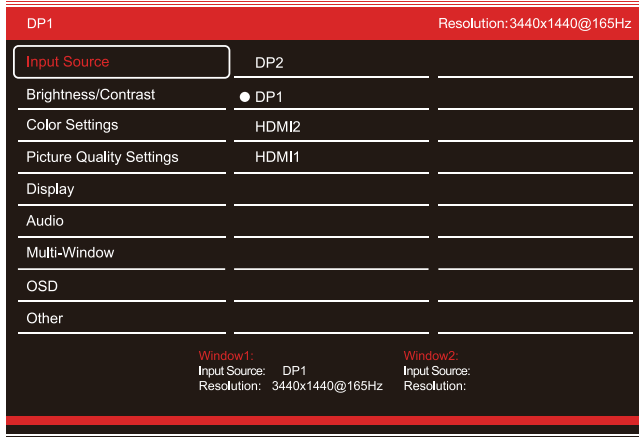

M / ▲ / ▼ MOVE & ADJUST
MENU(M) SELECT

PICTURE MODE		VALUE
Input Source	Select the input source	DP1, DP2, HDMI1, HDMI2

Brightness / Contrast

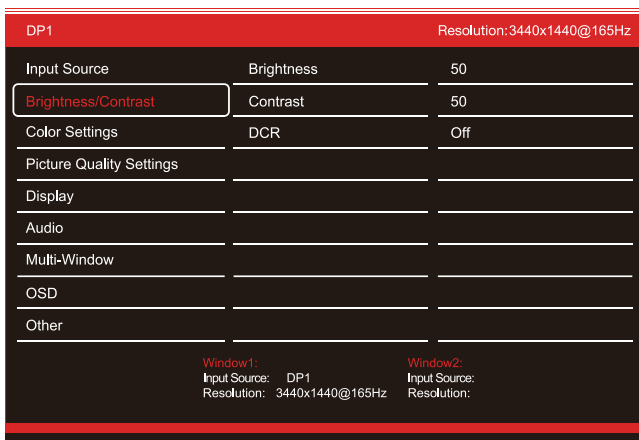

M / ▲ / ▼ MOVE & ADJUST
MENU(M) SELECT

FUNCTION		VALUE
BRIGHTNESS	Adjust the brightness	0 ~ 100
CONTRAST	Adjust the contrast	0 ~ 100
DCR	Set the dynamic contrast ratio mode	ON / OFF

CONTROL AND FUNCTION

Color Setting

DP1		Resolution:3440x1440@165Hz
Input Source	Gamma	2.2
Brightness/Contrast	Picture Mode	Standard
Color Settings	Color Temperature	Warm
Picture Quality Settings	Hue	50
Display	Saturation	50
Audio	Low Blue Light	0
Multi-Window		
OSD		
Other		

Window1:
Input Source: DP1
Resolution: 3440x1440@165Hz

Window2:
Input Source:
Resolution:

M / ▲ / ▼ MOVE & ADJUST
MENU(M) SELECT

FUNCTION		VALUE
GAMMA	Adjust gamma rate (color depth)	2.0, 2.2, 2.4
PICTURE MODE	Adjust the image color setting	See table below
COLOR TEMPERATURE	Adjust the color setting	See table below
HUE	Adjust the hue	0 ~ 100
SATURATION	Adjust the color saturation	0 ~ 100
LOW BLUE LIGHT	Adjust the blue-light emittance	0 ~ 100

PICTURE MODE	
STANDARD	Provides standard contrast and sharpness
PHOTO	Enhances contrast, sharpness, and color of text
MOVIE	Provides film-based content for a cinema-like environment
GAME	Provides standard pictures suitable for games
FPS	Adjust brightness and improves visibility,
RTS	Provides film-based content for a cinema-like environment

COLOR TEMPERATURE	
WARM	Give the white color a reddish tint
NORMAL	Give the white color a neutral tint
COOL	Give the white color a blue-ish tint
USER ¹⁾	Set custom color temperature

1) To set custom color temperature (R,G,B values), select "USER" to set color temperature. Keep pushing 'Down' button on the monitor or the remote controller, then you will see Red, Green and Blue option

CONTROL AND FUNCTION

Picture Quality Settings

DP1		Resolution:3440x1440@165Hz
Input Source	Sharpness	50
Brightness/Contrast	Response Time	Off
Color Settings	Noise Reduction	Off
Picture Quality Settings	Super Resolution	Off
Display	Dynamic Luminance Control	Off
Audio		
Multi-Window		
OSD		
Other		

Window1
Input Source: DP1
Resolution: 3440x1440@165Hz

Window2
Input Source:
Resolution:

M / ▲ / ▼ MOVE & ADJUST
MENU(M) SELECT

FUNCTION		VALUE
SHARPNESS	Adjust the picture sharpness	0 ~ 100
RESPONSE TIME	Set the response time	LOW / MIDDLE / HIGH / OFF
NOISE REDUCTION	Reduce noise of the display image	LOW / MIDDLE / HIGH / OFF
SUPER RESOLUTION	Setup the proper resolution	LOW / MIDDLE / HIGH / OFF
DYNAMIC LUMINOUS CONTROL	Set the dynamic luminance control	ON / OFF

CONTROL AND FUNCTION

Display

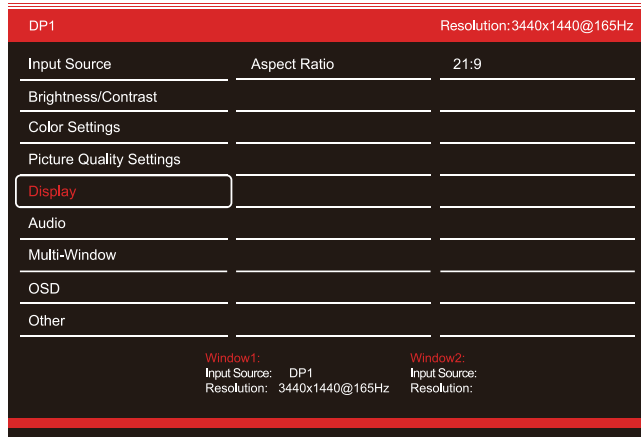

M / ▲ / ▼ MOVE & ADJUST
MENU(M) SELECT

FUNCTION		VALUE
ASPECT RATIO	Set the image aspect ratio	Wide Screen, Auto, 4:3, 1:1

Audio

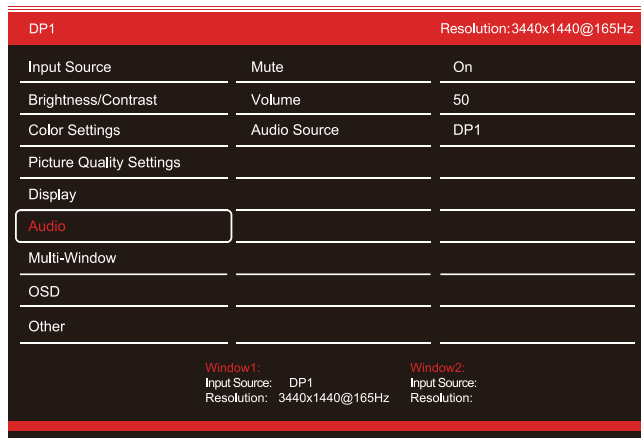

M / ▲ / ▼ MOVE & ADJUST
MENU(M) SELECT

FUNCTION		VALUE
MUTE	Set the sound on / off	ON / OFF
VOLUME	Adjust the volume	0 ~ 100

CONTROL AND FUNCTION

Setup

DP1		Resolution:3440x1440@165Hz
Input Source	Language	English
Brightness/Contrast	OSD H Position	50
Color Settings	OSD V Position	50
Picture Quality Settings	OSD Transparencu	20
Display	OSD Time Out	20
Audio	OSD Rotation	Normal
Multi-Window		
OSD		
Other		

Window1: Input Source: DP1 Resolution: 3440x1440@165Hz
 Window2: Input Source: Resolution:

M / ▲ / ▼ MOVE & ADJUST
MENU(M) SELECT

FUNCTION		VALUE
LANGUAGE	Set the language of the OSD menu	English & etc
OSD H-POSITION	Adjust the horizontal OSD position	0 ~ 100
OSD V-POSITION	Adjust the vertical OSD position	0 ~ 100
OSD TRANSPARENCY	Set the OSD menu background	0 ~ 100
OSD TIMEOUT	Set the OSD display time	5 ~ 100
OSD ROTATION	Adjust the OSD rotation	NORMAL, 90, 180, 270

CONTROL AND FUNCTION

Other

DP1 Resolution:3440x1440@165Hz		
Input Source	FreeSync (Adaptive Sync)	Off
Brightness/Contrast	HDR	Off
Color Settings	MPRT	Off
Picture Quality Settings	Flicker Free	On
Display	Light Effect	On
Audio	Reset	
Multi-Window		
OSD		
Other		

Window1: Input Source: DP1 Resolution: 3440x1440@165Hz
Window2: Input Source: Resolution:

M / ▲ / ▼ MOVE & ADJUST
MENU(M) SELECT

FUNCTION		VALUE
FREE SYNC (Adaptive)	Set the graphic-intensive mode by scene	ON / OFF
HDR	Set the HDR function (requires HDMI 2.0 input)	ON / OFF
MPRT	Set the moving picture response time * Turn on 1 ms response time mode	ON / OFF
FLICKER FREE	Set the Flicker Free function	ON / OFF
LIGHT EFFECT	Turn on the Light Effect function	ON / OFF
RESET	Reset the monitor settings to the factory default	

SPECIFICATION

Model No.		VZ-27CGM
	Size & Type	27"
LCD	Panel Type	27" LED Backlit Monitor
	Pixel Pitch (mm)	0.3114 (H) x 0.3114 (V) mm
	Brightness	350 cd/m ²
	Contrast Ratio	3000 : 1
	Viewing Angle	178° / 178°
	Display Color	16.7 Million Colors
	Response Time	< 1ms (Gray to Gray)
	Resolution	1920 (H) x 1080 (V)
	Aspect Ratio	16 : 9
	Speaker	3 W x 2
	Operating Temperature	32°F ~ 122°F / 0°C ~ 50°C
	Operating Humidity	5 ~ 90% RH
	Weight	Net : 7.7 lb / 3.5 kg Gross : 11.28 lb / 5.11 kg
	INTERFACE	HDMI INPUT x 2, DP INPUT x 2, AUDIO OUPUT x 1
	Safety & EMC Certification	CE / FCC(A) / RoHS
	Electrical Ratings	DC 12V (AC100 ~ 240V (50/60Hz))
	Power Consumption	≤ 32 W
	Accessories	Power Adapter x 1, HDMI Cable x 1, Manual x1, Stand x 1

TROUBLESHOOTING GUIDE

- Check the following before calling for service.
- If the same problems continue after checking, contact the reseller you purchased the monitor from.

At start	We recommend that you test with different input sources when you have trouble with the current input source. If symptom persists, follow the instructions below. After following the instructions below, please contact us at 1-888-99-VIEWZ.
No image or Noise on the screen	<ul style="list-style-type: none"> - Make sure the cable is correctly plugged into the outlet. - Make sure the power cable is correctly plugged into the monitor. - Make sure the cable is correctly connected between monitor & source. - Check the brightness setting and see if brightness is set to 'Ø'. - Check the video source.
Incorrect display or Half display	<ul style="list-style-type: none"> - Check your video source - Reset video source : connection, cable replacement, setting & more
Flickering and shadow image	<ul style="list-style-type: none"> - Check your input source setting for resolution and phase (Hz)
The audio function is not working	<ul style="list-style-type: none"> - Check the volume and make sure MUTE is not on - Check HDMI / Audio port cable connection
LED is flickering or no image	<ul style="list-style-type: none"> - Check the interface cable connection and make sure it's plugged in correctly - Check the input source
Blank spaces are showing	<ul style="list-style-type: none"> - Check the input source - Check HDMI / DP cable connection - Check the resolution setting
Monitor power LED is off and not turn on	<ul style="list-style-type: none"> - Check the power cable and power adapter
'Check Signal Cable' keep showing	<ul style="list-style-type: none"> - Check the input source cable connection - Check the input source status

TERMS OF WARRANTY / RMA

- The warranty period for this monitor is 1 year. The warranty will be voided for the scenarios listed below.
- You can also download the manual and information on VIEWZ web site: VIEWZUSA.COM

Cases of Non-Warranty Coverage	When power feed to the monitor exceeds capacity and causes damage.
	Accident, Abuse, Misuse, Neglect, Fire, Water/liquids, Lightning or any act of nature.
	Damaged by dropping, throwing and hitting the monitor.
	Failure caused by user's attempt to modify the product.
	Failure by limited life of parts such as LED lamps and any other consumables.
	Damaged by using third party power cable, unstable power input and electric shock.

* Above information can be changed without notification - please check our website or contact ViewZ representative for the latest RMA service policy.

* When shipping the monitor for RMA, make sure to pack safely to ensure the monitor is not damaged during shipping.

WARRANTY

ViewZ USA LIMITED 1 YEAR WARRANTY

What and Who is Covered by this Limited Warranty and for How Long

ViewZ USA warrants this product to be free from defects in material and workmanship for 1 year to the original owner of this product. The limited warranty is valid only for the original purchaser of the product.

What ViewZ USA Will Do

At their sole discretion, ViewZ USA will repair or replace any product or product part that is defective. If ViewZ USA chooses to replace a defective product or part, a replacement product or part will be shipped to you at no charge, but you must pay any labor costs.

What is Not Covered; Limitations

ViewZ USA disclaims any liability for damage to mounts, adapters, displays, projectors, other property, or personal injury resulting, in whole or in part, from improper installation, modification, use or misuse of its products.

ViewZ USA disclaims all other warranties, express or implied, including warranties of merchantability and fitness for a particular purpose. ViewZ USA is not responsible for incidental or consequential damages, including but not limited to, inability to use its products or labor costs for removing and replacing defective products or parts. Some states do not allow the exclusion or limitation of incidental or consequential damage, so the above limitation or exclusion may not apply to you.

What Customers Must Do for Limited Warranty Service

If you discover a problem that you think may be covered by the warranty you MUST REPORT it in writing to the address below within thirty (30) days. Proof of purchase (an original sales receipt) from the original consumer purchaser must accompany all warranty claims. Warranty claims must also include a description of the problem, the purchaser's name, address, and telephone number. General inquiries can be addressed to ViewZ USA Customer Service at 1-888-998-4399. Warranty claims will not be accepted over the phone or by fax.

ViewZ USA
Attn: Warranty Claim
177 W. Orangethorpe Ave.
Placentia, CA 92870

How State Law Applies

This warranty gives you specific legal rights, and you may also have other rights which vary from state to state.

Disclaimer

ViewZ USA intends to make this manual accurate and complete. However, ViewZ USA makes no claim that the information contained herein covers all details, conditions or variations, nor does it provide for every possible contingency in connection with the installation or use of this monitor. The information contained in this document is subject to change without notice or obligation of any kind. ViewZ USA makes no representation of warranty, expressed or implied, regarding the information contained herein. ViewZ USA assumes no responsibility for accuracy, completeness or sufficiency of the information contained in this document.

Contact Us

NORTH AMERICA
177 W. Orangethorpe Ave.
Placentia, CA 92870
USA and Canada
Phone: 1-888-998-4399
Fax: 1-714-996-1138
Other Locations
Phone: (001) 888-998-4399
Fax: (001) 714-996-1138

© ViewZ USA