

VZ-IP-PVMN SERIES

10" IP PUBLIC VIEW MONITOR

IP-PVM N USER MANUAL



ViewZ[®]
www.viewzusa.com

This device complies with NDAA (National Defense Authorization Act).

Please read this manual thoroughly before use, and keep it handy for future reference.

CONTENTS

Safety Instruction	3
1. Mark Indication & Substance	4
2. Warning	4
3. Caution	5
4. Operational Temperature & Humidity	5
5. Dot Defect (dead pixel) of TFT	5
6. FCC RF INTERFERENCE STATEMENT	6
Installation	7
1. Package	7
2. Interface	8
3. Connect External Equipments.....	9
4. Remote Control Function	11
Function	12
1. Monitor Button Function	13
2. OSD Control and Function	14
3. Media Card Control and Function	22
Mounting Guide	25
Specification	26
Trouble Shooting	29
RMA	30
Warranty	31

SAFETY INSTRUCTION

Important Safety Instruction

1. Read all warnings.
2. Follow all instructions to ensure longevity of monitor.
3. Do not place the monitor near water.
4. Clean only with dry cloth.
5. Do not block any ventilation openings. Install in accordance with the manufacturer's instructions.
6. Do not install near any heat sources such as radiators, heat registers, stoves, or other heat generating devices.
7. Do not override the safety purpose of the polarized or grounding-type plug.
8. A polarized plug has two blades with one wider than the other.
9. A grounding type plug has two blades and a third grounding prong.
10. The wide blade and the third prong are provided for your safety.
11. If the provided plug does not fit into your outlet, consult with electrician for replacement of the outlet.
12. Protect the power cord from being walked on or pinched particularly at plugs, convenience receptacles and the point where it connects to the monitor.
13. Only use attachment/accessories specified by the manufacturer.
14. Use only with the cart, stand, tripod, bracket or table specified by the manufacturer or sold with the monitor. When a cart is used, use caution when moving the cart & monitor in combination to avoid injuries.
15. Unplug the monitor during lightning storms or when unused for long periods of time.
16. Refer all servicing to qualified service personnel. Servicing is required when the monitor has been damaged in any way.



The monitor shall not be exposed to dripping or splashing and objects containing liquids, such as vases shall not be placed near the monitor.

The monitor should have ample distance (e.g. 10cm) from the wall for sufficient ventilation.

SAFETY INSTRUCTION

Important Safety Instruction

Mark Indication and Substance



CAUTION : TO REDUCE THE RISK OF ELECTRICAL SHOCK,
DO NOT REMOVE COVER (OR BACK). NO USER
SERVICEABLE PARTS INSIDE. REFER SERVICING TO
QUALIFIED SERVICE PERSONNEL



This symbol is intended to alert the user to the presence of uninsulated & dangerous voltage within the monitor's enclosure that may be of sufficient magnitude to constitute a risk of electric shock to persons.



This symbol is intended to alert the user to the presence of important operating and maintenance (servicing) instructions in the literature accompanying the monitor.

Warning

- Do not use damaged or loose cables and plug.
- Do not pull the plug out by the wire nor touch the plug with wet hands.
- Use only a properly grounded plug and receptacle.
- Do not connect too many extension cords or plugs to one outlet.
- Do not excessively bend the plug and wire.
- Do not disconnect the power cord while it's still plugged into the monitor.
- Do not place any heavy objects on the power cord. Damage to the cord may cause shock or fire.
- Never open the monitor. There are no user-serviceable parts inside and opening will void warranty.
- Removing covers may expose you to dangerous shock hazards or other risks.
- Keep any heating devices away from the power cable and monitor.
- Do not place the monitor near water.
- Do not insert objects of any kind into the monitor's open slots, as they may touch dangerous voltage points.
- Please follow the laws and regulations of your municipality to dispose the monitor properly.
- Do not use the monitor in high temperature, humid, dusty or oily areas.
- Do not install the monitor where it will be exposed to continual vibration.
- Keep the plastic packaging out of children's reach.
- If any damage is detected upon first opening the box, contact agency from which you bought the monitor directly.
- If your monitor does not operate normally – in particular, if there is any unusual sound or smell coming from the monitor – unplug it immediately and contact an authorized dealer or the service center.

SAFETY INSTRUCTION

Important Safety Instruction

Caution

- If the connector between the plug and the pin is dusty or dirty, clean it properly using a dry cloth.
- Make sure to unplug the power cord before cleaning the monitor.
- Make sure to leave a gap between monitor and wall.
- Do not drop the monitor when moving it.
- Place your monitor in a location with low humidity and minimum dust.
- Install the monitor base on a showcase or shelf so that the end of the base does not protrude from the showcase or shelf.
- Do not place the monitor on an unstable or small surface area.
- Do not install inside a vehicle.
- Disconnect the plug from the outlet during storms or lightning or if it has not been used for a long time.
- Do not try to move the monitor by pulling on the power cord.
- Do not cover the vents on the monitor.
- When moving the monitor, turn off and unplug the power cord. Make sure that all cables, including HDMI cable and cables connected to other devices, are disconnected before moving it.
- Place the monitor out of children's reach, as they could damage it by hanging onto it.

Available Temperature & Humidity

- Operating Temperature : 32°F ~ 104°F / 0°C ~ 40°C
- Operating Humidity : 20 ~ 70% RH

Dot Defect (dead pixel) of TFT

ViewZ monitors are manufactured using high-end semiconductor technology with precision ratings of 99.9% and above. However, it may be the case that certain RGB and white pixels seem darker (or entirely unlit i.e. black).

Modern production methods cannot guarantee an absolute fault-free monitor. To this effect, no LED manufacturer can guarantee a defect free panel. A few isolated pixel or sub-pixel faults are considered tolerable and different policies exist that govern the amount of these tolerable values.

While most pixel faults occur in isolated regions, a cluster of dead pixels or sub-pixels can sometimes form for which a separate ruling applies. A cluster is defined as an area of 5x5 pixels. ViewZ's policy on pixel failure: either as an isolated fault or in the form of a cluster is outlined on the website: www.viewzusa.com

FCC RF INTERFERENCE STATEMENT

Note

This equipment has been tested and found to comply with the limits for a Class A digital device, pursuant to part 15 of the FCC Rules. These limits are designed to provide reasonable protection against harmful interference when the equipment is operated in a commercial environment.

This equipment generates, uses, and can radiate radio frequency energy and, if not installed and used in accordance with the instruction manual, may cause harmful interference to radio communications. Operation of this equipment in a residential area is likely to cause harmful interference in which case the user will be required to correct the interference at his own expense.

- Reorient or relocate the receiving antenna.
- Increase the separation between the equipment and receiver.
- Connect the equipment into an outlet on a circuit different from that to which the receiver is connected.
- Consult the dealer or an experienced radio, TV technician for help.
- Only shielded interface cable should be used.

Finally, any changes or modifications to the equipment by the user not expressly approved by the grantee or manufacturer could void the users authority to operate such equipment.

► DOC COMPLIANCE NOTICE

This digital apparatus does not exceed the Class A limits for radio noise emissions from digital apparatus set out in the radio interference regulation of Canadian Department of communications.

INSTALLATION

Installation Tools

The following tools may be required depending on your installation.

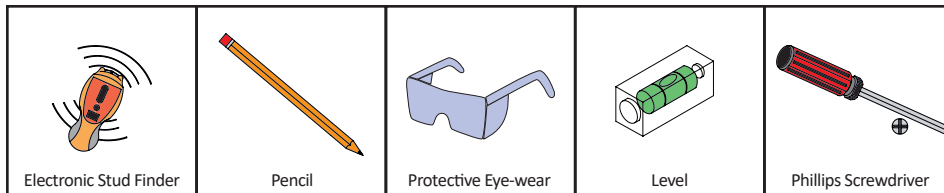

Assembly Components - provided

Your ViewZ monitor is shipped with all proper installation hardware and components. If there are parts missing and/or damaged, please stop the installation and contact ViewZ USA at (888)-998-4399.

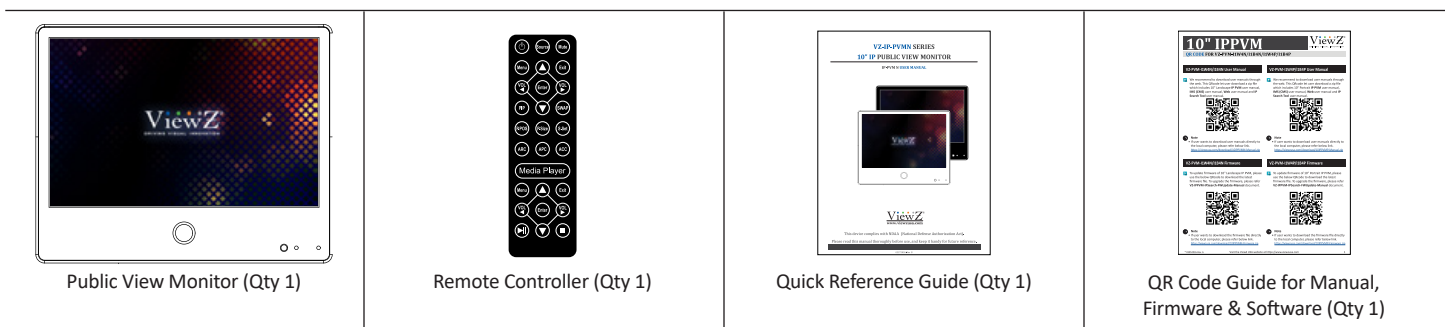

Mounting Option

Your ViewZ monitor is compatible with ViewZ monitor mounts. For more information, please contact ViewZ USA at (888)-998-4399.

Wall Mount

- | | | | |
|--|--|--|---|
| <ul style="list-style-type: none"> Part # WM05  | <ul style="list-style-type: none"> Flat Wall Mount VESA 75 ~ 100 | <ul style="list-style-type: none"> Part # WM11  | <ul style="list-style-type: none"> Tilting $\pm 20^\circ$ Swivel $\pm 30^\circ$ VESA 50 ~ 100 |
| <ul style="list-style-type: none"> Part # SCM  | <ul style="list-style-type: none"> Tilting $-90^\circ \sim 90^\circ$ Swivel 180° VESA 75 | <ul style="list-style-type: none"> Part # SM01  | <ul style="list-style-type: none"> Tilting $-35^\circ \sim +35^\circ$ Swivel 180° VESA 75 ~ 100 |

CONNECT EXTERNAL EQUIPMENTS

Interface Input Ports

The following image is the description of interface input ports

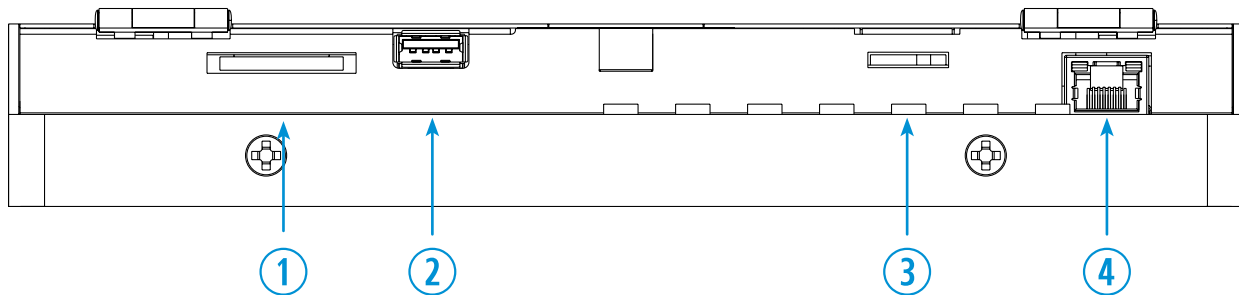

1. SD CARD (MEDIA PLAYER) IN
2. USB (MEDIA PLAYER) IN
3. Micro SD (RECORDING) IN
4. ETHERNET 10/100 (P.o.E)

CONNECT EXTERNAL EQUIPMENTS

Record Camera - Micro SD Card Installation of 10" PVM (VZ-PVM-I1W4N/I1B4N)

The following image is the description of Micro SD card installation

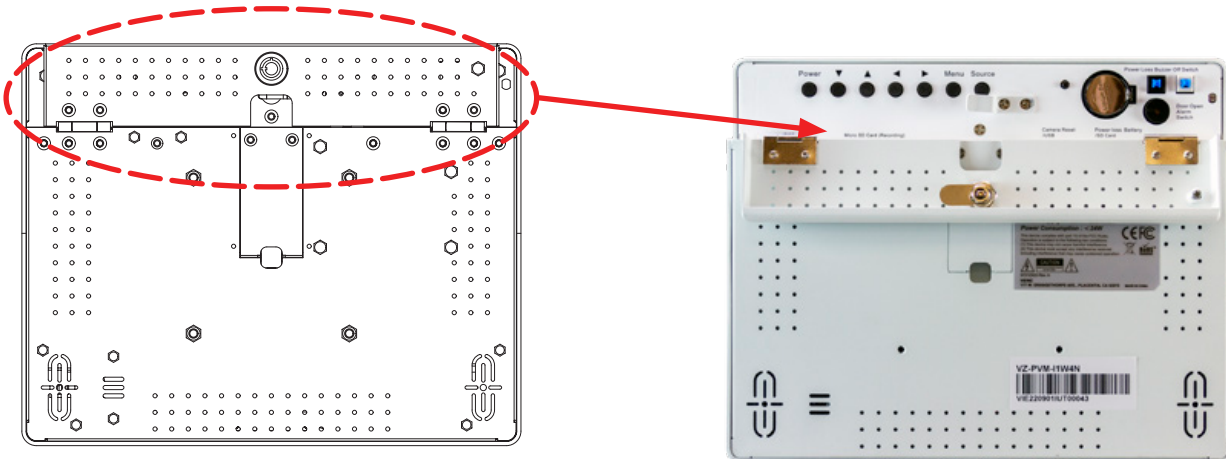

Micro SD
Card Slot

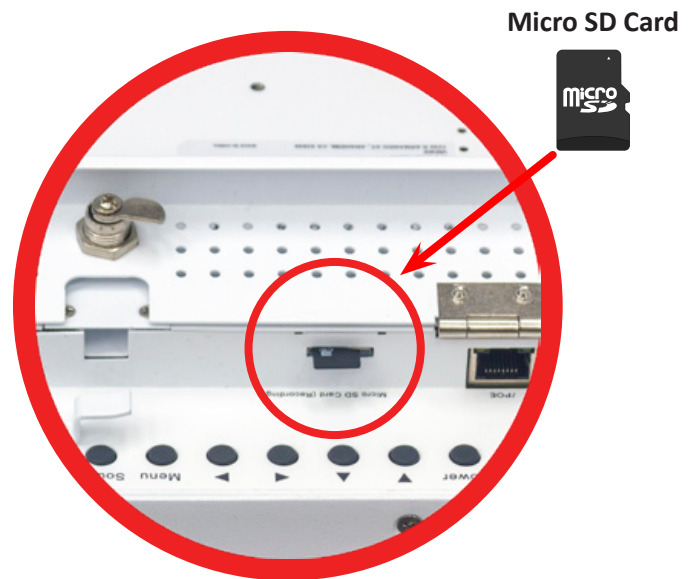

Micro SD Card

- **Connect Micro SD card**

1. Open the back case and find the Micro SD card slot
2. Insert Micro SD card to Micro SD Card slot
3. To use recording function, please refer the page 88, 89, 89 & 91 of 'VZ-AIPVM-Web-UserManual'



Note

To use recording function, user should remove every files and format the Micro SD card

CONNECT EXTERNAL EQUIPMENTS

Record Camera - Micro SD Card Installation of 10" PVM (VZ-PVM-I1W4N/I1B4N)

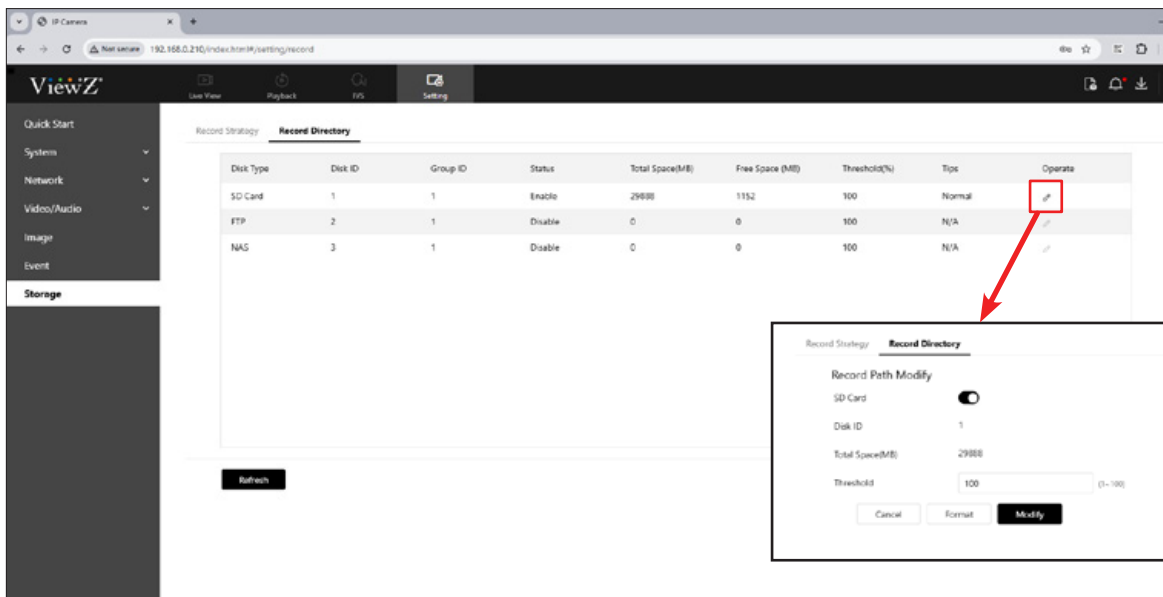
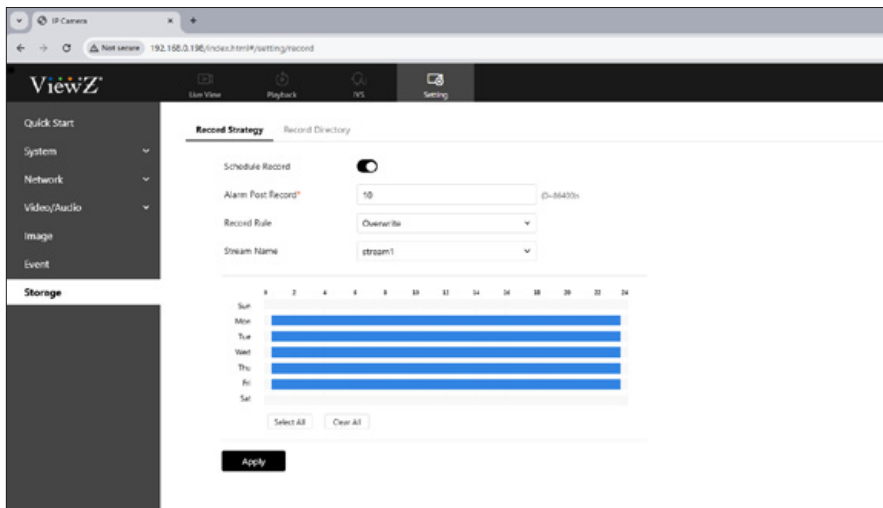

About the detailed feature of recording, please refer page 100 ~ 103 & 15 ~ 17 of 'VZ-AIPVM-Web-UserManual'

REMOTE FUNCTION

Remote Controller

Remote Controller

1. **Power**
2. **Source** - Select Input Source
3. **Mute** - Turn off the sound
4. **Menu** - Enter / Exit OSD
5. **Exit** - Exit OSD with saving current value
6. **Left & Right** ◀(VOL)▶, **Up & Down** ▲▼
7. **Enter** - Select current setting value on Input source
8. **No Function**

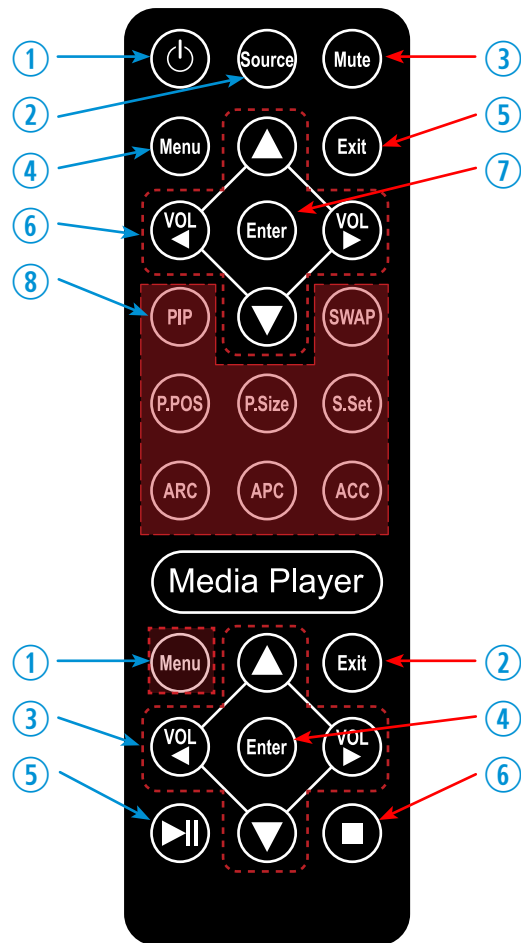

Media Controller

1. **No Function**
2. **Exit** - Exit Media Player Menu
3. **Left & Right** ◀(VOL)▶, **Up & Down** ▲▼
4. **Enter** - Confirm the selection
5. **Stop & Play** - Freeze the media play
6. **Stop** - Stop the media play

Display image, sound and custom settings can be adjusted in OSD (On Screen Display) menu by remote controller.
To adjust monitor setting value :

1. Press the **'MENU'** button to enter the OSD menu
2. Press the **'INPUT'** button to select input source
3. Press the **▲ / ▼** buttons to select the desired sub-menu. The selected submenu will be highlighted
4. Press the **'ENTER'** button to enter the sub-menu for adjusting items
5. Change the value you wish to adjust by using the **◀ / ▶** buttons
6. Press the **'MENU'** button to confirm / exit for saving adjustment value on sub-menu
7. Without entering OSD MENU, press **◀ / ▶** buttons to adjust the audio volume
8. Press the **'MUTE'** button to on / off audio - audio only works with VGA / AV input

CONTROL AND FUNCTION

On Monitor, Front Area

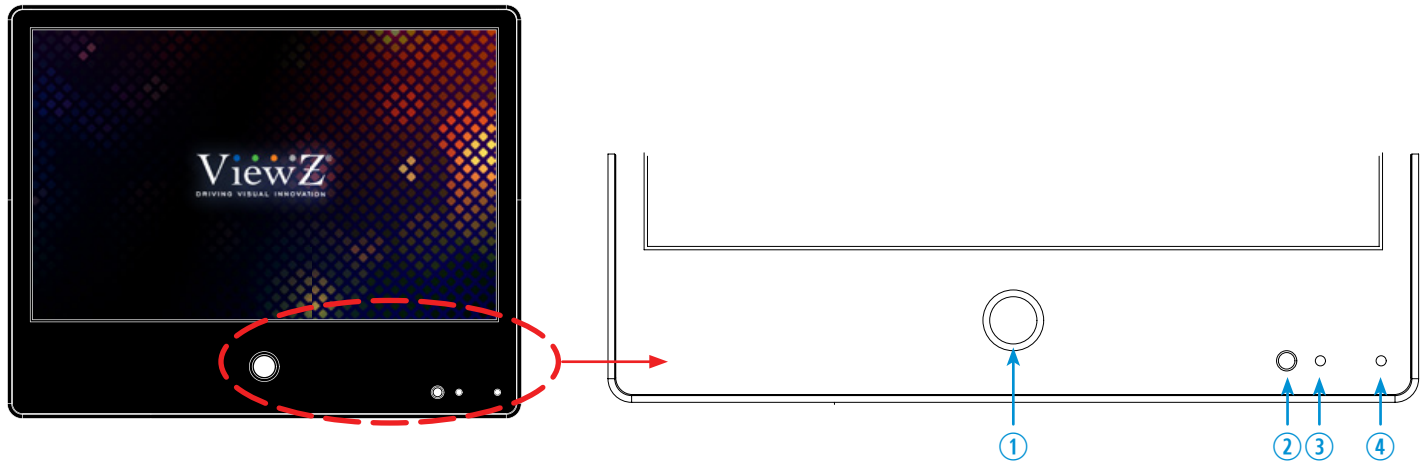

1. Built-in Camera / Motion Detection
The monitor will display the built-in camera's video
Built-in camera has the motion detection function
2. IR Sensor
Sensor for the remote controller
3. LED Indicator
Blue color: monitor on
Red color : monitor off
4. Recording Indicator LED
User can choose a blinking LED color - white, red, green, blue, yellow and no color.

CONTROL AND FUNCTION

On Monitor, Button Control

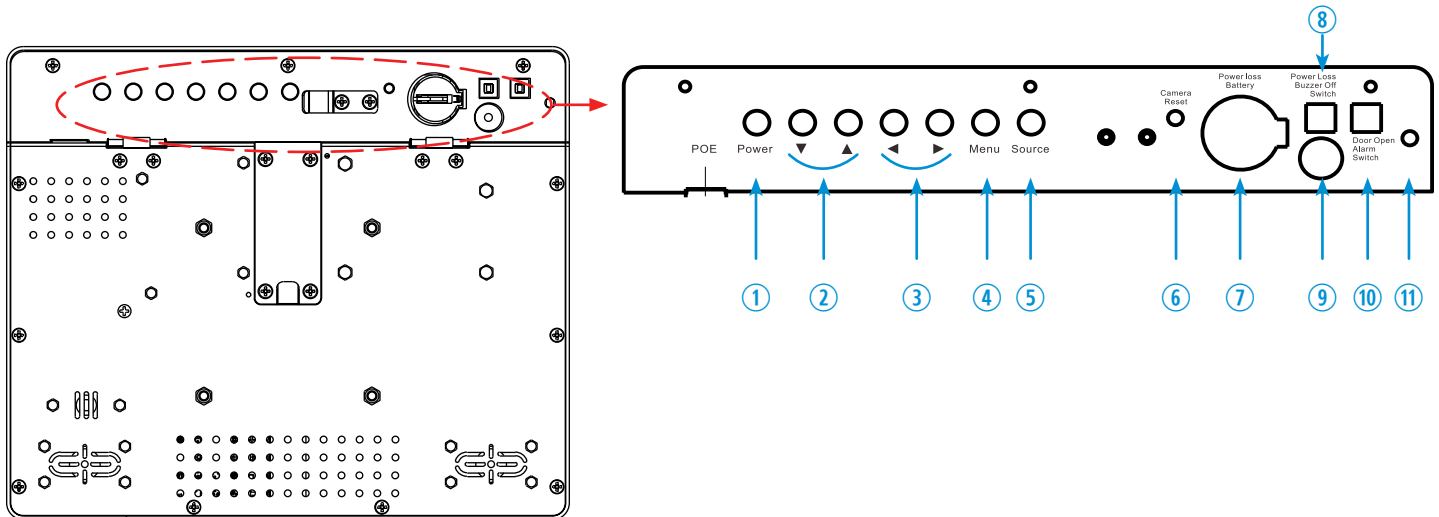

- | | |
|---|---|
| <ol style="list-style-type: none"> 1. Power
To turn the monitor power on / off 2. Up & Down ▲ ▼
To switch a menu on OSD 3. Left & Right ◀ (VOL) ▶
To change the value on the selected menu 4. Menu
To enter or exit the OSD / Select a menu on OSD 5. Source
To select an input source | <ol style="list-style-type: none"> 6. Camera Reset
To reset the camera settings to the factory default 7. Power Loss Buzzer Battery 8. Power Loss Buzzer Off Switch
To turn off the buzzer of power loss alarm 9. Power Loss Buzzer 10. Door Open Alarm Switch
To make alarm when door open 11. Video Obstruction Alarm Lighting Sensor |
|---|---|

Monitor Button Function

All picture, sound settings and setup can be adjusted in OSD (On Screen Display) menu.

To adjust the OSD screen:

1. Press the **MENU** button to enter the **OSD MENU**
2. Press the ◀ / ▶ buttons to select the desired **main-MENU**. The selected **main-MENU** is highlighted
3. Press the ▲ / ▼ buttons to select the desired **sub-MENU**. The selected **sub-MENU** is highlighted
4. Change the value you wish to adjust by using the ◀ / ▶ buttons
5. Press the **MENU** button to confirm the adjustment on **sub-MENU**
6. Press the **MENU** button to exit the **sub-MENU** and go back to the **main-MENU**
7. Press the **MENU** button to exit the **OSD MENU**

CONTROL AND FUNCTION

Select Input Source

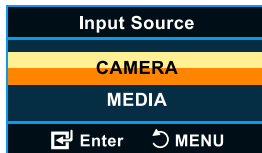

Press 'SOURCE' button on monitor or 'INPUT' button on remote controller.

Press ▲ / ▼ button to change input source and then press ◀ / ▶ button to select input source on monitor.

Press ▲ / ▼ button to change input source and then press ◀ / ▶ button or Enter to select input source on remote controller.

Volume



Press ◀ / ▶ buttons to adjust volume on monitor

Press ◀ / ▶ buttons to adjust volume on remote controller

Detect Source Signal Message

If you connect any input source, monitor will display current input source resolution and frequency.

CONTROL AND FUNCTION

Picture

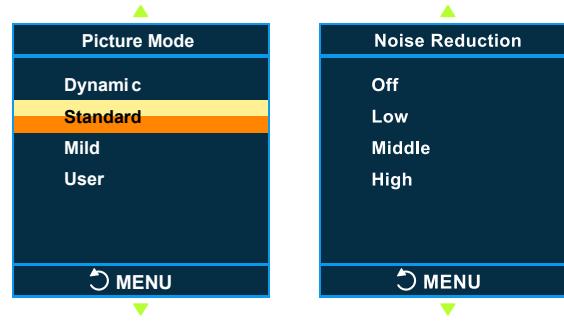
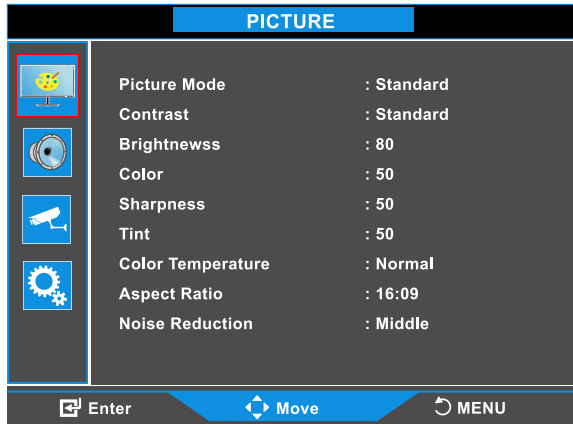

▲/▼ MOVE ◀/▶ SELECT(ADJUST) MENU RETURN

FUNCTION		VALUE
PICTURE MODE	Adjust the image color setting	See table below
CONTRAST	Adjust the contrast	0 ~ 100
BRIGHTNESS	Adjust the brightness	0 ~ 100
COLOR	Adjust the color	0 ~ 100
SHARPNESS	Adjust the sharpness	0 ~ 100
TINT ¹⁾	Adjust the tint	0 ~ 100
COLOR TEMPERATURE	Adjust the color setting	See table on page 16
ASPECT RATIO	Adjust the video format	See table on page 16
NOISE REDUCTION	Adjust the noise level	OFF / LOW / MIDDLE / HIGH

1) Only available in Composite (video) input

PICTURE MODE	
DYNAMIC	Provides enhanced contrast and sharpness
STANDARD	Provides standard contrast and sharpness
MILD	Reduces contrast and sharpness
USER	Applies user selected values - brightness, contrast, color and hue

CONTROL AND FUNCTION

Picture

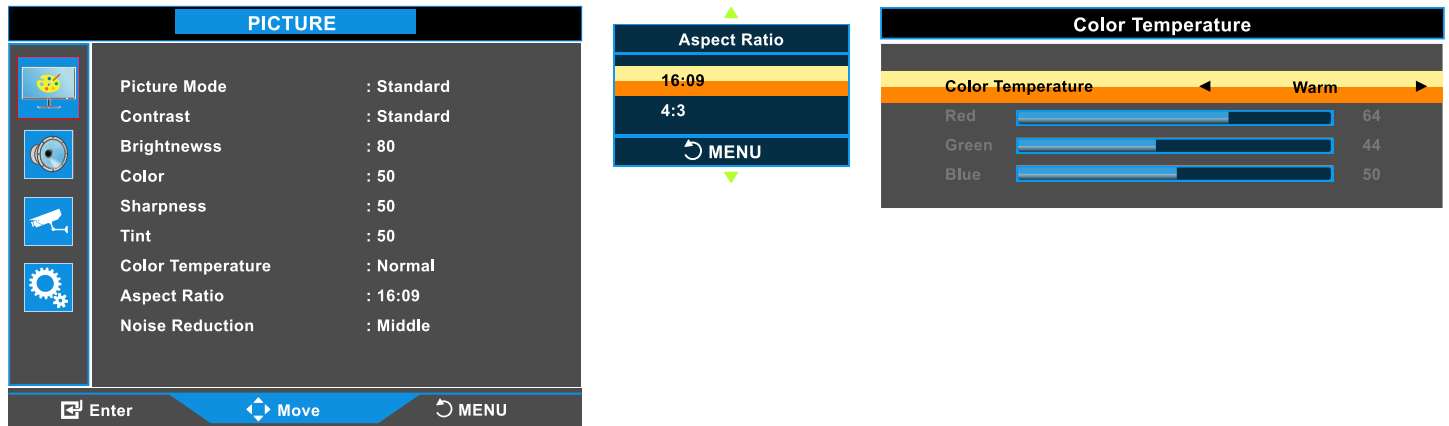

▲/▼ MOVE ◀/▶ SELECT(ADJUST) MENU RETURN

COLOR TEMPERATURE

WARM	Give the white color a reddish tint
NORMAL	Give the white color a neutral tint
COOL	Give the white color a blue-ish tint

ASPECT RATIO

16 : 9	Sets the image size to 16 : 9
4 : 3	Sets the image size to 4 : 3

CONTROL AND FUNCTION

Sound

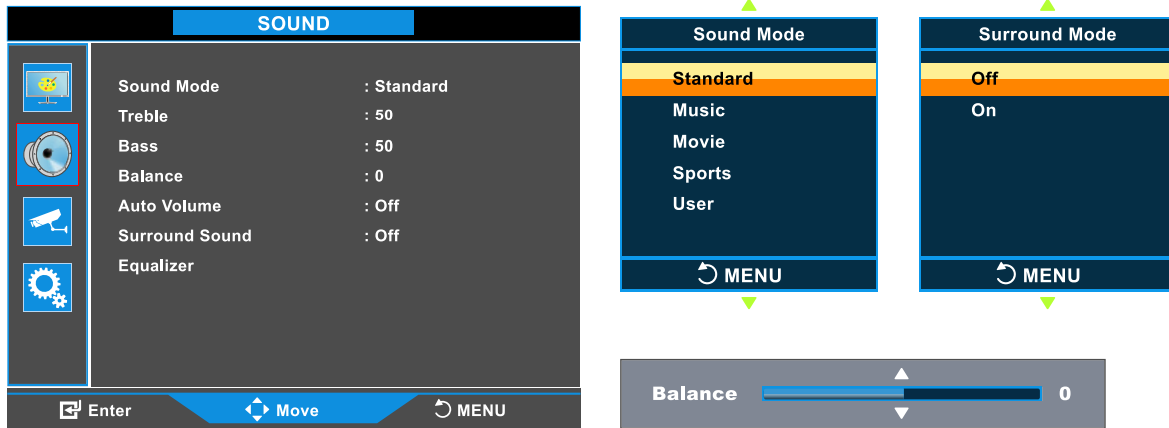

▲/▼ MOVE ◀/▶ SELECT(ADJUST) MENU RETURN

	FUNCTION	VALUE
SOUND MODE	Selects one of the presets	STANDARD / MUSIC / MOVIE / SPORTS / USER
TREBLE ¹⁾	Adjusts the bass level	0 ~ 100
BASS ¹⁾	Adjusts the bass level	0 ~ 100
BALANCE	Adjusts the balance	0 ~ 100
AUTO VOLUME	Adjusts the volume	0 ~ 100
SURROUND MODE	Adjusts preset sound mode	ON / OFF
EQUALIZER ¹⁾	Set the equalizer	

1) Only available in USER MODE

CONTROL AND FUNCTION

Advance - Adjust Alarm / LED Indicator Color

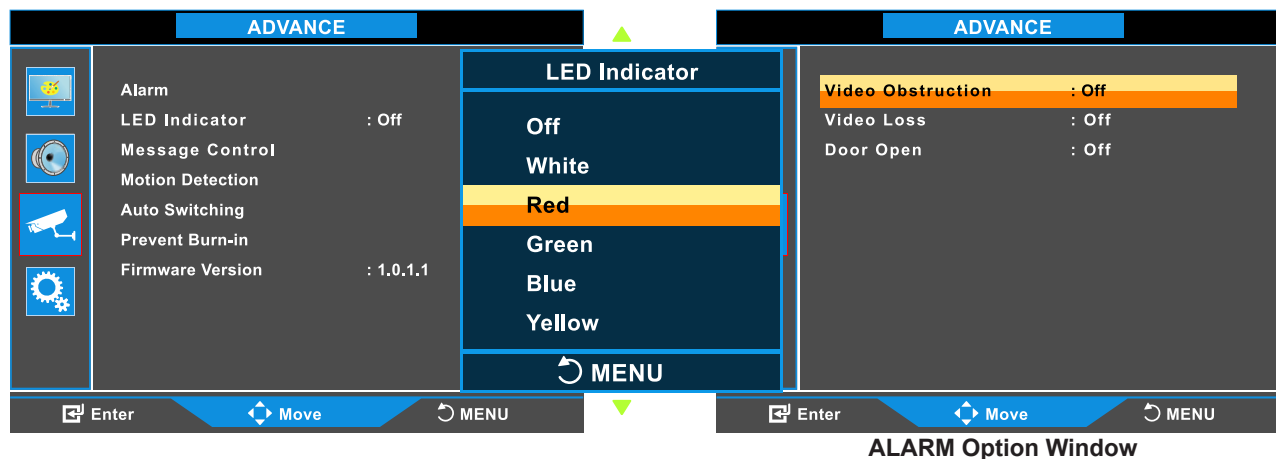

ALARM Option Window

▲/▼ MOVE ◀/▶ SELECT(ADJUST) MENU RETURN

FUNCTION		VALUE
ALARM	See table below	
LED INDICATOR	Sets the color of recording indicator LED	OFF/ WHITE / RED / GREEN / BLUE / YELLOW
MESSAGE CONTROL	See table on page 17	
MOTION DETECTION	See table on page 17	
AUTO SWITCHING	See table on page 18	
PREVENT BURN-IN	Set periodic image retention	OFF / ON
FIRMWARE VERSION	Display the OSD firmware version	

FUNCTION		VALUE
VIDEO OBSTRUCTION	Set the alarm of PVM's camera block	OFF / ON
VIDEO LOSS	Set the alarm of PVM's video signal loss	OFF / ON
DOOR OPEN	Set the alarm of PVM's backside door open	OFF / ON

CONTROL AND FUNCTION

Advance - Setup Displaying Message / Motion Detection



MESSAGE CONTROL Option Window

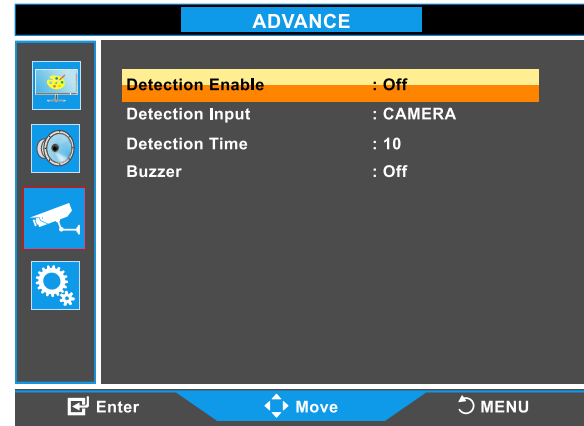

MOTION DETECTION Option Window

▲/▼ MOVE ◀/▶ SELECT(ADJUST) MENU RETURN

FUNCTION		VALUE
MESSAGE CONTROL	Enables the recording text	OFF / ON
MESSAGE BLINK	Sets the blinking text image interval time	OFF / ON / 1 ~ 3 sec
MESSAGE ¹⁾	Selects the preset text image	TEXT 1 - RECORDING TEXT 2 - RECORDING IN PROGRESS TEXT 3 - SURVEILLANCE IN PROGRESS TEXT 4 - VIDEO RECORDING IN PROGRESS

1) PRESET TEXT IMAGE supports for all 6 OSD languages

FUNCTION		VALUE
DETECTION ENABLE	Enables the MOTION DETECTION function	OFF / ON
DETECTION INPUT	Selects the input source for Motion Detection	CAMERA / MEDIA
DETECTION TIME	Adjusts the time to display the swapped image / video which is triggered by motion detection. If user selects '10', the monitor will keep showing the swapped image/videos for 10 seconds whether or not motion detected. If there is no motion detection for 10 seconds, monitor will display original image/videos.	3 ~ 100 sec
Buzzer	Enable the buzzer sound when motion detect	OFF / ON

CONTROL AND FUNCTION

Advance - Adjust Auto Switching

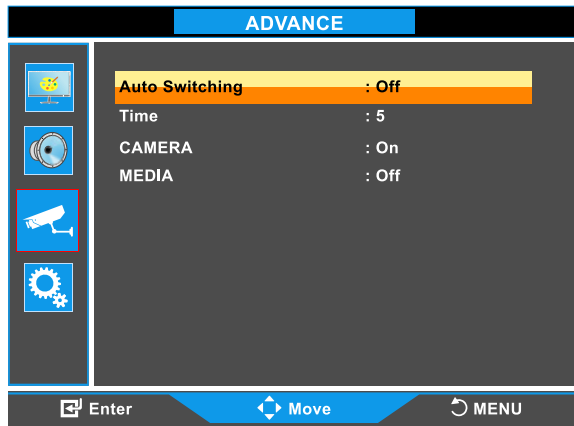

AUTO SWITCHING Option Window

▲/▼ MOVE ◀/▶ SELECT(ADJUST) MENU RETURN

	FUNCTION	VALUE
AUTO SWITCHING	Enables the AUTO SWITCHING function	OFF / ON
TIME	Adjusts the time which the monitor displays one input source before switching to the other * Only selected two input sources can be displayed	3 ~ 100 sec
CAMERA	Sets the CAMERA input source as the switching display source	OFF / ON
MEDIA	Sets the MEDIA input source as the switching display source	OFF / ON

CONTROL AND FUNCTION

Option

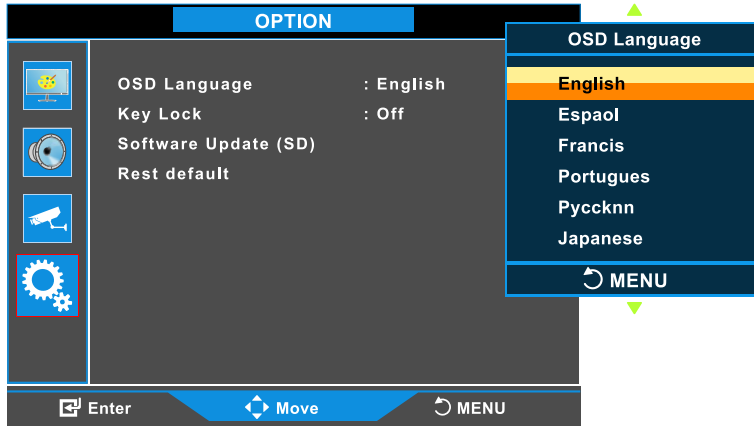

▲/▼ MOVE ◀/▶ SELECT(ADJUST) MENU RETURN

	FUNCTION	VALUE
OSD LANGUAGE	Sets the language of the OSD menu	English, Spanish, French Japanese, Portuguese
KEY LOCK ¹⁾	Enable / disable the monitor button	On / Off
SOFTWARE UPDATE	Update the system software via USB drive	
RESET DEFAULT	Resets the monitor settings to the factory default	

1) To unlock this mode, press 'MENU' button & hold for 5 seconds - on the monitor. Refer to page 11's monitor buttons.

CONTROL AND FUNCTION

Media Card Interface

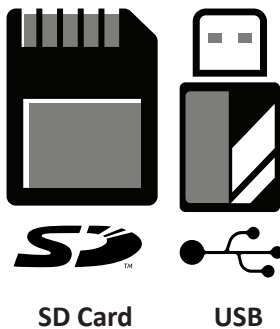
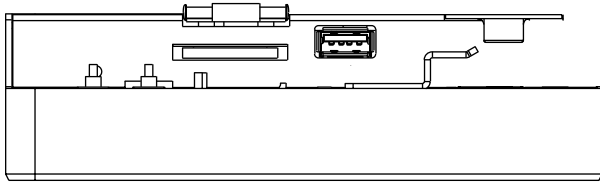

- **Connect USB or SD card**
 1. Connect USB or SD card devices to USB or SD Card slot located at the back of the PVM
- **Remove USB or SD card**
 1. Return to the main menu and press exit
 2. Remove the USB & SD card from the slot
- **Priority of Play**
 1. SD card content
 2. USB content
- **Caution** - when media player activated, the priority of playing media type is;
 1. Movie
 2. Photo
- **Caution** - The media file should be located in the root location. If the media file is located in the sub folder, media file will not automatically play

Media Player OSD

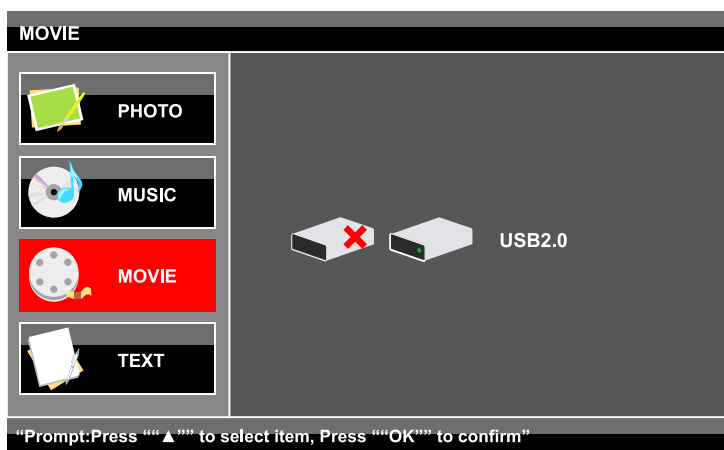

FUNCTION

PHOTO	Displays image files from the SD Card or USB
MUSIC	Plays music files from the SD Card or USB
MOVIE	Plays video files from the SD Card or USB
TEXT	Plays text files from the SD Card or USB

CONTROL AND FUNCTION

Photo

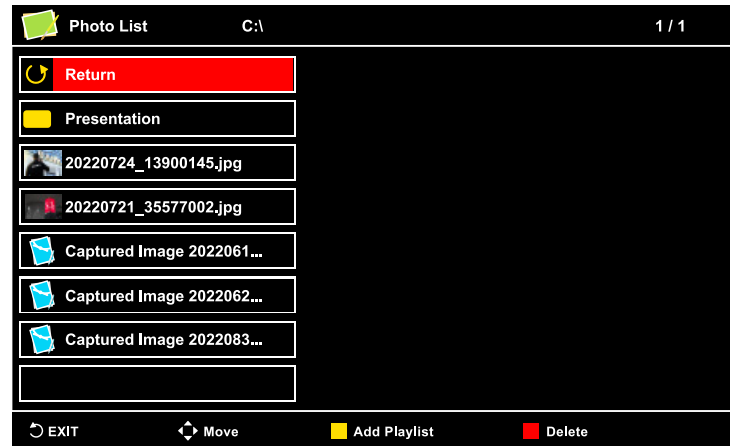
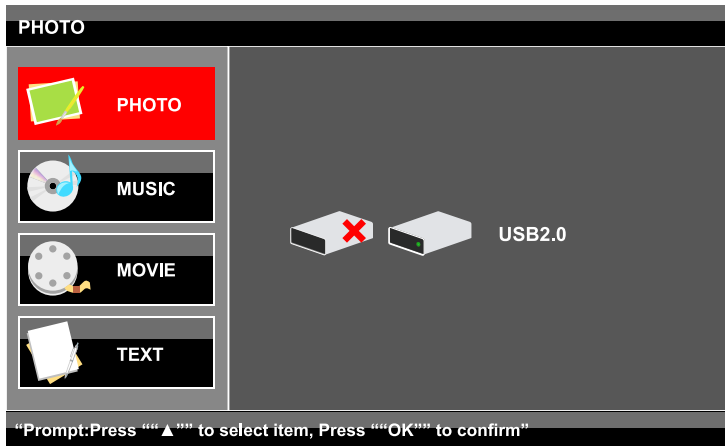

When you select **PHOTO** on the entry menu of Media play:

1. Press the **ENTER** button and then press **◀ / ▶ / ▲ / ▼** buttons to select a image file to display.
2. Press the **ENTER** button to select photo files to play and then press **▶ ||** button to display the image or slide-show.
**Note: If you have more than one video file, selected video files will display one by one.*
3. Press **▶ ||** button to pause the slide-show and show only one image file in a non "slide-show" mode.
4. Press the **EXIT / ■** button to return to the **Media OSD MENU**

Music

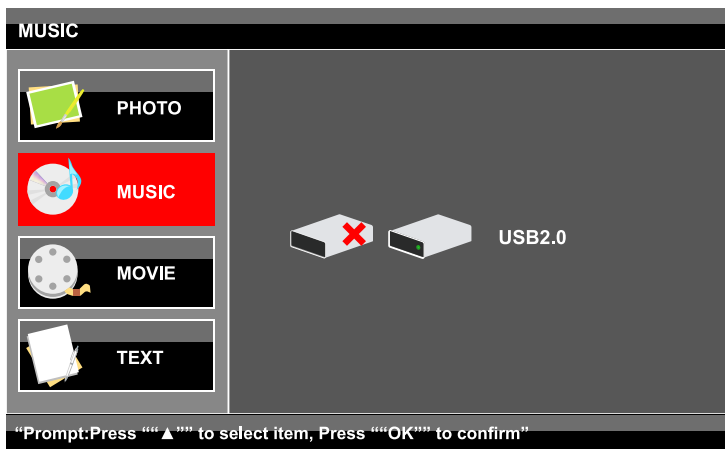

When you select **MUSIC** on the entry menu of Media play:

1. Press the **ENTER** button and then press **◀ / ▶ / ▲ / ▼** buttons to select a music file to play.
2. Press the **ENTER** button to select music files to play and then press **▶ ||** button to play the music files.
**Note: If you have more than one music file, selected music files will play one by one.*
3. Press **▶ ||** button to pause playing music.
4. Press the **EXIT / ■** button to return to the **Media OSD MENU**.

CONTROL AND FUNCTION

Movie

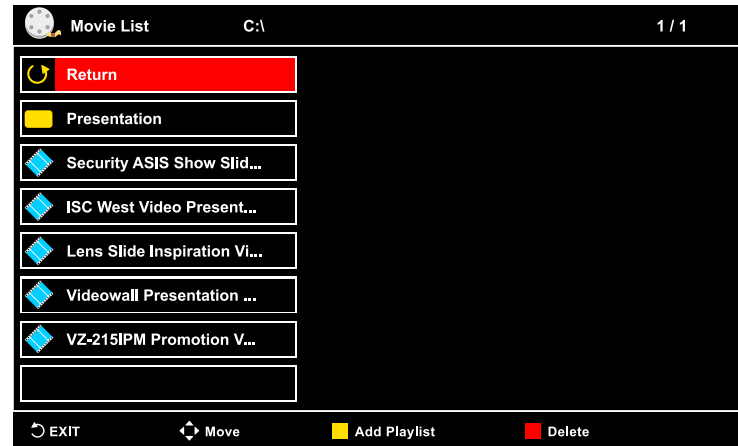
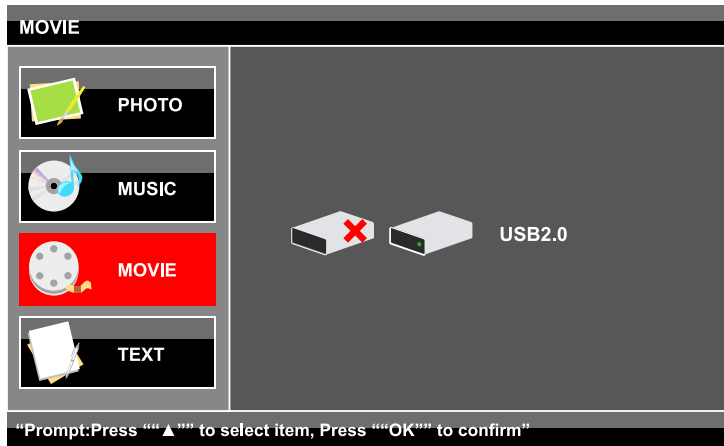

When you select **MOVIE** on the entry menu of Media play:

1. Press the **ENTER** button and then press ◀ / ▶ / ▲ / ▼ buttons to select a video file to play.
2. Press the **ENTER** button to select video files to play and then press ▶ || button to play the video files.
**Note: If you have more than one movie file, selected movie files will display one by one.*
3. Press ▶ || button to pause the video file.
4. Press the **EXIT / ■** button to return to the **Media OSD MENU**

Text

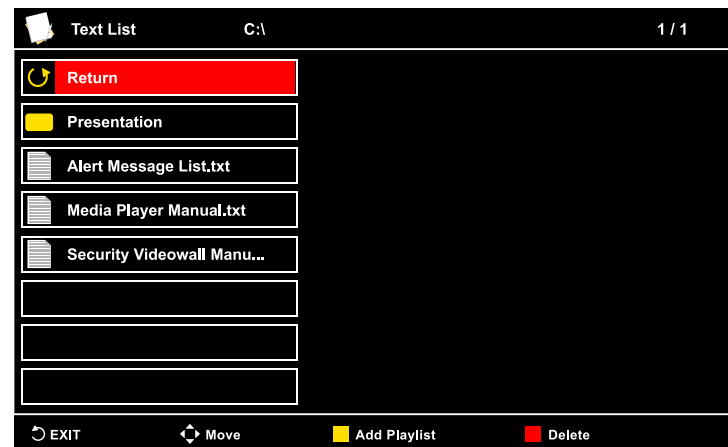
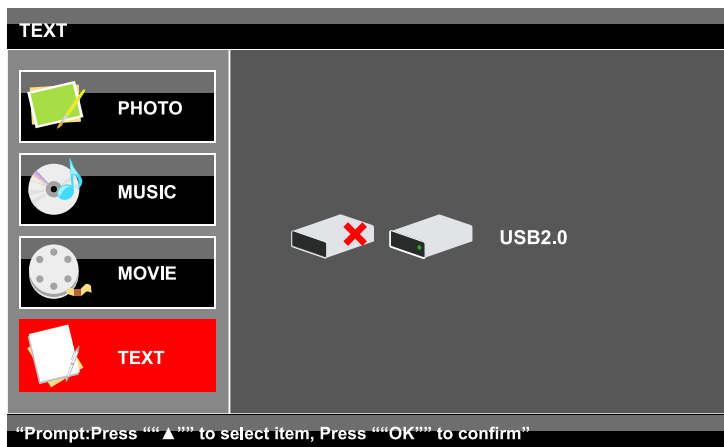

When you select **TEXT** on the entry menu of Media play:

1. Press the **ENTER** button and then press ◀ / ▶ / ▲ / ▼ buttons to select a text file to play.
2. Press the **ENTER** button to select text files to play and then press ▶ || button to play the text file.
**Note: If you have more than one text file, selected text files will display one by one.*
3. Press ▶ || button to pause the text file.
4. Press the **EXIT / ■** button to return to the **Media OSD MENU**

MOUNTING GUIDE

Wall Mounting (Optional)

VZ-PVM monitors are suitable for VESA wall mount (not included).

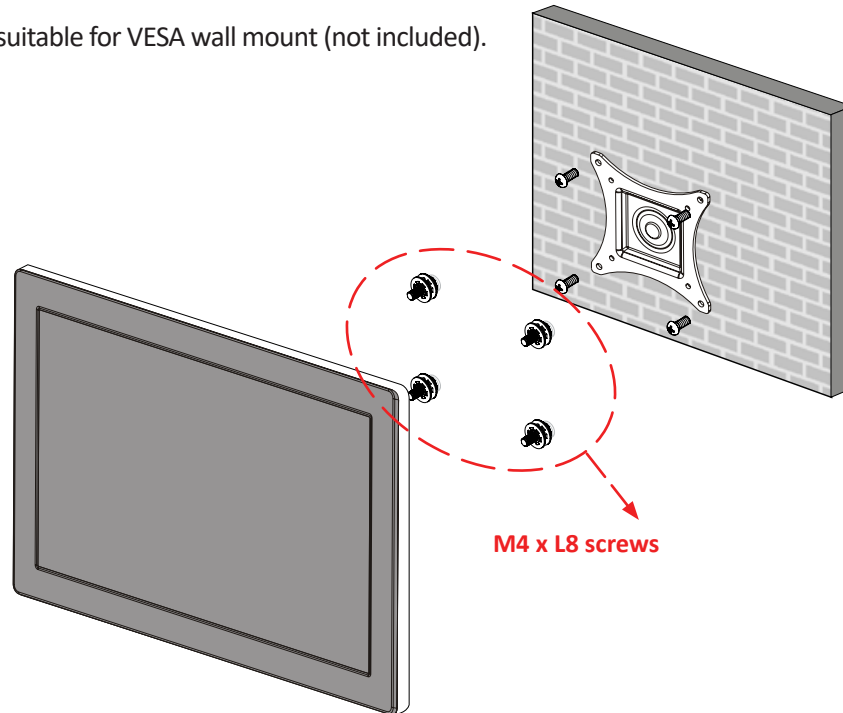

1. VZ-PVM-I1W4N : VESA WALL MOUNT 75mm x 75mm
2. VZ-PVM-I1B4N : VESA WALL MOUNT 75mm x 75mm

! Attention!
VZ-PVM-I1W4N (75x75) : You must use 4 * M4 x L8 screws to assemble this monitor and the wall mount bracket.

! WARNING !
 If user uses screws longer than
 M4 x L8 mm for 75 x 75 - VZ-PVM-I1W4N / VZ-PVM-I1B4N
 it may cause damage to the unit. Please use bolt of correct size and length as instructed.

! Mounting Safety !
 At least two people are recommended to safely install the mount.

SPECIFICATION

Model No.		VZ-PVM-I1W4N / VZ-PVM-I1B4N
Size & Type		10.1"
LCD	Panel Type	10.1" LED Backlit Monitor
	Pixel Pitch	0.1695 (H) x 0.1695 (V) mm
	Brightness	350 cd/m ²
	Contrast Ratio	900 : 1(Typ.)
	Viewing Angle	R/L : 85°/ 85° U/D : 85°/ 85°
	Display Color	16.7 Million Colors
	Response Time	30 ms
Resolution		1280 (H) x 800 (V)
Case Type		Metal
Active Display Area		216.96 (H) x 135.60 (V) mm
Aspect Ratio		16 : 10
Color Temperature		Warm / Normal / Cool / User
Speaker		2W x 2
Operating Temperature		32°F ~ 104°F / 0°C ~ 40°C
Operating Humidity		5 ~ 90% RH
Weight		Net : 4.62 lb / 2.1 kg Gross : 7.05 lb / 3.2 kg
INTERFACE		RJ-45 for IP Camera & Power x 1, Micro SD Card In x 1, SD Card In x 1, USB In x 1
Safety & EMC Certification		CE / FCC / NDAA / ROHS
Electrical Ratings	P.o.E	37 - 52V === 0.5A
Power Consumption		≤ 24 W
Accessories		Quick Manual, Remote controller, Door Key, Manual & Software CD

SPECIFICATION

Camera Specification

	Parameters	Description	
Production Information	Product Name	2MP IP module	
Main Chipset	Encode Chipset	NT98529	
	Sensor	SONY IMX307	
Camera	Resolution	1920 (W) x 1080(H)	
	Video System	NTSC / PAL	
	Digital Zoom	Support	
	Minimum illumination	Color: 0.01 Lux@ (F1.2, AGC ON) / B&W: 0.0 Lux@ (IR LED ON)	
	Day & Night Mode	Support - Auto (ICR)	
	Electronic Shutter Speed	Auto/Manual, 1/5 ~ 1/20,000s	
	S/N Ratio	55dB	
	Wide Dynamic Range (WDR)	True WDR	
Lens	Lens Type	Board	
	Focal Length of the Lens	2.8 mm	
External interface	Network Interface	RJ45 10 /100 Base-T	
	Reset Button	Support	
	Storage	Built-in Micro SD slot, up to 256G	
Video	Video Encode	H.264 (Main profile), H.265, MJPEG, CBR, VBR	
	Multi-Stream	Main stream ,2 nd stream, 3 rd stream	
	Video Resolution and Frame Rate		NTSC 60Hz:30fps / PAL 50Hz:25fps Main stream: 1920*1080 @ 25/30fps 1280*720 @ 25/30fps 2 nd stream: D1, VGA, 640×360, CIF, QVGA @ 25/30fps 3 rd stream: VGA, CIF, QVGA @ 25/30fps
		Video Bit Rate Control	1Mbps-8Mbps,support CBR/VBR
		Video Bit Rate	Main stream: 100kbps ~ 12Mbps 2 nd stream: 10kbps ~ 6Mbps 3 rd stream: 10kbps ~ 3Mbps
	Image Enhancement	Support HLC / BLC / Defog / WDR	
	White Balance	Auto	
	Gain Control	Auto / Manual	
	Noise Reduction	2D/3D DNR	
	Aisle Mode	Support	
	Smart IR	Support	
	Mirror	Support	
	Region of Interest	Off/On (8 Zone, Rectangle)	
	Motion Detection	Support	
	Privacy Masking	Support	

SPECIFICATION

Camera Specification

	Parameters	Description
Smart Function	Gun / Face / Full Body / Motion Detection	Support
	Intelligent Detection	Smart Motion, Single/Double Line Crossing, Multi-Loitering, Wrong Way, General Parameters, Single Bad, Gun Detect, Gun Detect, People Count, Intrusion
Network	Integration Protocol	ONVIF 22.06 (supported), SDK, CGI
	Network Protocol	IPv4/IPv6, 802.1x, HTTP, HTTPS, TCP/IP, UDP/IP, RTSP, DHCP, NTP, RTCP/RTP, PPPoE, SMTP, DNS, UPnP, FTP, ARP, SNMP, TLS/SSL
	Streaming Mode	Unicast
	Concurrent Access (# of Users)	10 users (Maximum 3ch 1080P)
	User Rights	Two roles: administrator and common users. The administrator can assign common users different rights.
WEB application	Language	English default
	Browser	Windows Edge / Firefox / Chrome
Recording Capacity		TF Card (EXT4 format, MAX256G)
	2MP - H.265 w/256G	30fps (11days) / 15fps (15days)
	2MP - H.264 w/256G	30fps (5days) / 15fps (7days)

Media Player Specification

	Description
External Storage	Support SD/SDHC CARD (Max 32GB), USB 2.0 HOST
VIDEO Format	RM, RMVB, AVI, DVIX, MKV, MOV, HDMOV, MP4, M4V, PMP, AVC, FLV, VOB, MPG, DAT, MPEG, TS, TP, M2TS, WMV, H.264, H.263, WMV9, VC-1, MPEG1/2/4
AUDIO Format	MPEG1/2/4, MP3, WMA, OGG, AAC, FLAC, APE, AC-3, DTS, ATRA, WAV, PCM
IMAGE Format	JPEG, TIF, PNG, BMP
VIDEO Resolution	1080P @60/50Hz, 1080i @60/50Hz, 720P @60/50Hz
VIDEO Play Control	AUTO, REPEAT, ZOOM, RESUME, TIME

TROUBLESHOOTING GUIDE

- Check the following before calling for service.
- If the same problems continue after checking, contact the reseller you purchased the monitor from.

At start	We recommend that you test with different input sources when you have trouble with the current input source. If symptom persists, follow the instructions below. After following the instructions below, please contact us at 1-888-99-VIEWZ.
No image or Noise on the screen	<ul style="list-style-type: none"> - Make sure the power cable is correctly plugged into the outlet - Make sure the power cable is correctly plugged into the monitor - Make sure the cable is correctly connected between monitor & source - Check brightness and see if brightness is set to 'Ø' - Check video source
Incorrect display or Half display	<ul style="list-style-type: none"> - Check your video source - Reset video source : connection, cable replacement, setting & more
Flickering and shadow image	<ul style="list-style-type: none"> - Check your input source setting for resolution and phase (Hz)
The audio function is not working	<ul style="list-style-type: none"> - Check the volume and make sure MUTE is not on - Check HDMI / Audio port cable connection
LED is flickering or no image	<ul style="list-style-type: none"> - Check the interface cable connection and make sure it's plugged in correctly - Check the input source

TERMS OF WARRANTY / RMA

- The warranty period for this monitor is 3 years. The warranty will be voided for the scenarios listed below.
- You can also download the manual and information at VIEWZ web site: VIEWZUSA.COM

Cases of Non-Warranty Coverage	When power feed to the monitor exceeds capacity and causes damage
	Accident, Abuse, Misuse, Neglect, Fire, Water/liquids, Lightning or any act of nature
	Damaged by dropping, throwing and hitting the monitor
	Failure caused by users attempt to modify the product
	Failure by limited life of parts such as LED Lamps and any other consumables
	Damaged by using third party power cable, unstable power input and electric shock

* Above information can be changed without notification - please check our website or contact ViewZ representative for latest RMA service policy.

* When shipping the monitor for RMA, make sure to pack safely to ensure the monitor is not damaged during shipping.

WARRANTY

ViewZ USA LIMITED 3 YEAR WARRANTY

What and Who is Covered by this Limited Warranty and for How Long

ViewZ USA warrants this product to be free from defects in material and workmanship for 3 years to the original owner of this product. The limited warranty is valid only for the original purchaser of the product.

What ViewZ USA Will Do

At the sole discretion of ViewZ USA, ViewZ USA will repair or replace any product or product part that is defective. If ViewZ USA chooses to replace a defective product or part, a replacement product or part will be shipped to you at no charge, but you must pay any labor costs.

What is Not Covered; Limitations

ViewZ USA disclaims any liability for damage to mounts, adapters, displays, projectors, other property, or personal injury resulting, in whole or in part, from improper installation, modification, use or misuse of its products.

ViewZ USA disclaims all other warranties, express or implied, including warranties of merchantability and fitness for a particular purpose. ViewZ USA is not responsible for incidental or consequential damages, including but not limited to, inability to use its products or labor costs for removing and replacing defective products or parts. Some states do not allow the exclusion or limitation of incidental or consequential damage, so the above limitation or exclusion may not apply to you.

What Customers Must Do for Limited Warranty Service

If you discover a problem that you think may be covered by the warranty you MUST REPORT it in writing to the address below within thirty (30) days. Proof of purchase (an original sales receipt) from the original consumer purchaser must accompany all warranty claims. Warranty claims must also include a description of the problem, the purchaser's name, address, and telephone number. General inquiries can be addressed to ViewZ USA Customer Service at 1-888-998-4399. Warranty claims will not be accepted over the phone or by fax.

ViewZ USA
Attn: Warranty Claim
1030 N ARMANDO ST.,
ANAHEIM, CA 92806

How State Law Applies

This warranty gives you specific legal rights, and you may also have other rights which vary from state to state.

Disclaimer

ViewZ USA intends to make this manual accurate and complete. However, ViewZ USA makes no claim that the information contained herein covers all details, conditions or variations, nor does it provide for every possible contingency in connection with the installation or use of this monitor. The information contained in this document is subject to change without notice or obligation of any kind. ViewZ USA makes no representation of warranty, expressed or implied, regarding the information contained herein. ViewZ USA assumes no responsibility for accuracy, completeness or sufficiency of the information contained in this document.

Contact Us

NORTH AMERICA
1030 N ARMANDO ST.,
ANAHEIM, CA 92806
USA and Canada
Phone: 1-888-998-4399
Fax: 1-714-996-1138
Other Locations
Phone: (001) 888-998-4399
Fax: (001) 714-996-1138

© ViewZ USA