

VZ-43, 55 & 65UHD

43", 55" & 65" UHD LED MONITOR **USER MANUAL**

4K UHD LED Monitor

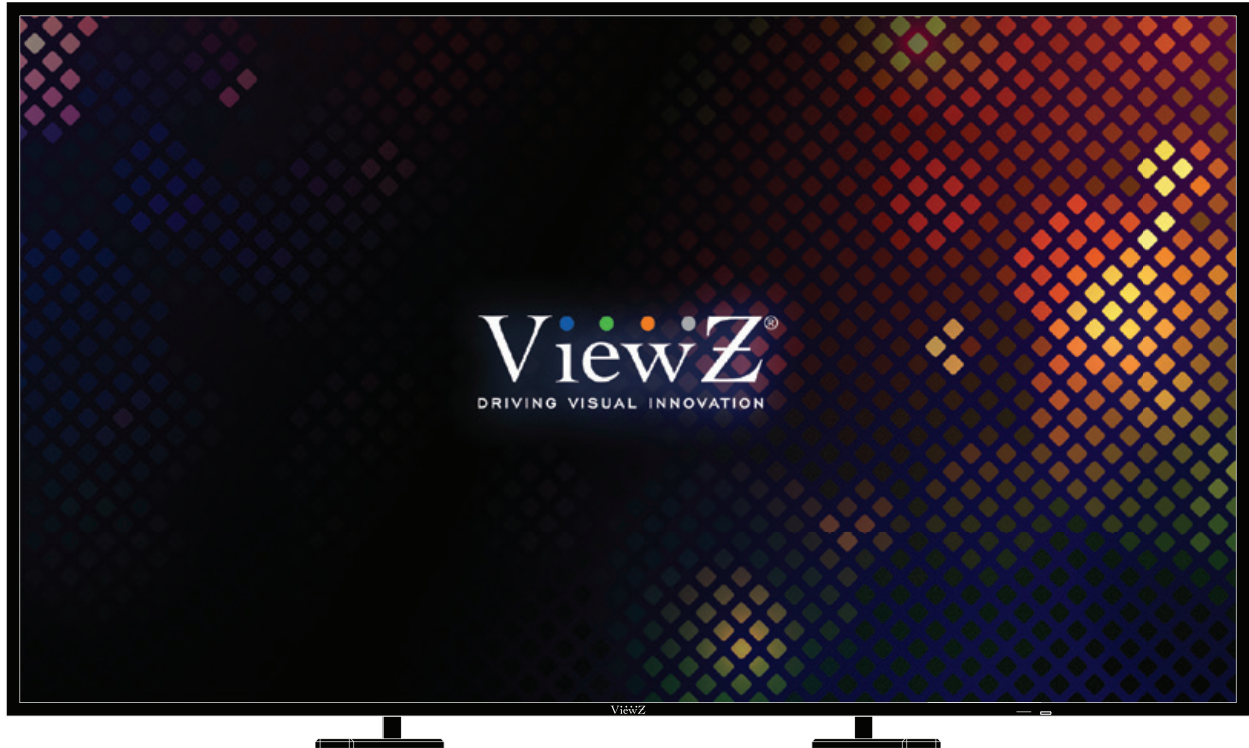

ViewZ[®]
www.viewzusa.com

Please read this manual thoroughly before use, and keep it handy for future reference.

CONTENTS

Safety Instruction	3
1. Mark Indication & Substance	4
2. Warning & Caution	4
3. FCC RF INTERFERENCE STATEMENT	6
4. RoHS Compliance	7
Installation	8
1. Feature & Package	8
2. Stand Installation	9
3. Interface	10
Function	11
1. Remote Function	11
2. Monitor Button Function	12
3. OSD Control and Function	13
4. Media Player	24
RS232 Command	28
Mounting Guide	32
Specification	33
Trouble Shooting	34
RMA	35
Warranty	36

SAFETY INSTRUCTION

Important Safety Instruction

1. **Read all warnings.**
2. Follow all instructions to ensure longevity of monitor.
3. Do not place the monitor near water.
4. Clean only with dry cloth.
5. Do not block any ventilation openings. Install in accordance with the manufacturer's instructions.
6. Do not install near any heat sources such as radiators, heat registers, stoves, or other heat generating devices.
7. Do not override the safety purpose of the polarized or grounding-type plug.
8. A polarized plug has two blades with one wider than the other.
9. A grounding type plug has two blades and a third grounding prong.
10. The wide blade or the third prong is provided for your safety.
11. If the provided plug does not fit into your outlet, consult with electrician for replacement of the outlet.
12. Protect the power cord from being walked on or pinched particularly at plugs, convenience receptacles and the point where it connects to the monitor.
13. Only use attachment/accessories specified by the manufacturer.
14. Use only with the cart, stand, tripod, bracket or table specified by the manufacturer or sold with the monitor. When a cart is used, use caution when moving the cart & monitor in combination to avoid injuries.
15. Unplug the monitor during lightning storms or when unused for long periods of time.
16. Refer all servicing to qualified service personnel. Servicing is required when the monitor has been damaged in any way.



The monitor shall not be exposed to dripping or splashing and objects containing liquids such as vases shall not be placed near the monitor.

The monitor should have ample distance (e.g. 10cm) from the wall for sufficient ventilation.

SAFETY INSTRUCTION

Important Safety Instruction

Mark Indication and Substance



CAUTION : TO REDUCE THE RISK OF ELECTRICAL SHOCK,
DO NOT REMOVE COVER (OR BACK). NO USER
SERVICEABLE PARTS INSIDE. REFER SERVICING TO
QUALIFIED SERVICE PERSONNEL



This symbol is intended to alert the user to the presence of uninsulated & dangerous voltage within the monitor's enclosure that may be of sufficient magnitude to constitute a risk of electric shock to persons.



This symbol is intended to alert the user to the presence of important operating and maintenance (servicing) instructions in the literature accompanying the monitor.

Warning

- Do not use damaged or loose cables and plug.
- Do not pull the plug out by the wire nor touch the plug with wet hands.
- Use only a properly grounded plug and receptacle.
- Do not connect too many extension cords or plugs to one outlet.
- Do not excessively bend the plug and wire.
- Do not disconnect the power cord while it's still plugged into the monitor.
- Do not place any heavy objects on the power cord. Damage to the cord may cause shock or fire.
- Never open the monitor. There are no user-serviceable parts inside and opening will void warranty.
- Removing covers may expose you to dangerous shock hazards or other risks.
- Keep any heating devices away from the power cable and monitor.
- Do not place the monitor near water.
- Do not insert objects of any kind into the monitor's open slots, as they may touch dangerous voltage points.
- Please follow the laws and regulations of your municipality to dispose the monitor properly.
- Do not use the monitor in high temperature, humid, dusty or oily areas.
- Do not install the monitor where it will be exposed to continual vibration.
- Keep the plastic packaging out of children's reach.
- If any damage is detected upon first opening the box, contact agency from which you bought the monitor directly.
- If your monitor does not operate normally – in particular, if there is any unusual sound or smell coming from the monitor – unplug it immediately and contact an authorized dealer or the service center.

SAFETY INSTRUCTION

Important Safety Instruction

Caution

- If the connector between the plug and the pin is dusty or dirty, clean it properly using a dry cloth.
- Make sure to unplug the power cord before cleaning the monitor.
- Make sure to leave a gap between monitor and wall.
- Do not drop the monitor when moving it.
- Place your monitor in a location with low humidity and minimal dust.
- Install the monitor base on a showcase or shelf so that the end of the base does not protrude from the showcase or shelf.
- Do not place the monitor on an unstable or small surface area.
- Do not install inside a vehicle.
- Disconnect the plug from the outlet during storms or lightning or if it has not been used for a long time.
- Do not try to move the monitor by pulling on the power cord.
- Do not cover the vents on the monitor.
- When moving the monitor, turn off and unplug the power cord. Make sure that all cables, including HDMI cable and cables connected to other devices, are disconnected before moving it.
- Place the monitor out of children's reach as they could damage it by hanging onto it.

Available Temperature & Humidity

- Operating Temperature : 32°F ~ 104°F / 0°C ~ 40°C
- Operating Humidity : 20 ~ 85% RH
- Storage Temperature : 50°F ~ 140°F / 10°C ~ 60°C
- Storage Humidity : 10 ~ 90% RH

Dot Defect (dead pixel) of TFT

ViewZ monitors are manufactured using high-end semiconductor technology with precision ratings of 99.9% and above. However, it may be the case that certain RGB and white pixels seem darker (or entirely unlit i.e. black).

Modern production methods cannot guarantee an absolute fault-free monitor. To this effect, no LED manufacturer can guarantee a defect free panel. A few isolated pixel or sub-pixel faults are considered tolerable and different policies exist that govern the amount of these tolerable values.

While most pixel faults occur in isolated regions, a cluster of dead pixels or sub-pixels can sometimes form for which a separate ruling applies. A cluster is defined as an area of 5x5 pixels. ViewZ's policy on pixel failure: either as an isolated fault or in the form of a cluster is outlined on the website: www.viewzusa.com

FCC RF INTERFERENCE STATEMENT

Note

This equipment has been tested and found to comply with the limits for a Class A digital device, pursuant to part 15 of the FCC Rules. These limits are designed to provide reasonable protection against harmful interference when the equipment is operated in a commercial environment.

This equipment generates, uses, and can radiate radio frequency energy and, if not installed and used in accordance with the instruction manual, may cause harmful interference to radio communications. Operation of this equipment in a residential area is likely to cause harmful interference in which case the user will be required to correct the interference at his own expense.

- Reorient or relocate the receiving antenna.
- Increase the separation between the equipment and receiver.
- Connect the equipment into an outlet on a circuit different from that to which the receiver is connected.
- Consult the dealer or an experienced radio, TV technician for help.
- Only shielded interface cable should be used.

Finally, any changes or modifications to the equipment by the user not expressly approved by the grantee or manufacturer could void the users authority to operate such equipment.

► DOC COMPLIANCE NOTICE

This digital apparatus does not exceed the Class A limits for radio noise emissions from digital apparatus set out in the radio interference regulation of Canadian Department of communications.

Statement

- VGA and XGA are the registered trademark of IBM.
- VESA is the trademark of Video Electronics Standard Association.
- HDMI, HDMI logo and High-Definition Multimedia Interface (high definition multimedia digital interface) are the trademark or registered trademark of HDMI Licensing LLC.



If some company or product trademark is not particularly stated, the use of trademark has been fully recognized. Do not alter, decompile, disassemble, decode or conduct reverse engineering to the software installed in the product, or it can be deemed as breach of the law.

RoHS COMPLIANCE

Note

Name and contents of toxic and hazardous substances or elements contained in the product.

COMPONENT	FUNCTION				VALUE	
	(Pb)	(Hg)	(Cd)	(Cr ⁶⁺)	(PBB)	(PBDE)
LCD Screen	X	○	○	○	○	○
Housing (Case)	○	○	○	○	○	○
PCB assembly ¹⁾	X	○	○	○	○	○
Power cord & cable	X	○	○	○	○	○
Metal parts	○	○	○	○	○	○
Packing materials ²⁾	○	○	○	○	○	○
Remote controller	X	○	○	○	○	○
Speaker	X	○	○	○	○	○
Accessories ³⁾	○	○	○	○	○	○

1) PCB assembly includes the PCB and the electronic components composed by the PCB

2) Packing materials include the carton, expandable polystyrene and etc.

3) Accessories include User Manual and etc.

○ : The toxic and hazardous substance contain the homogeneous materials which components do not exceed the required limit, prescribed in the GB/T26572-2011 standards.

X : The toxic and hazardous substance contain one or more homogeneous materials which component exceeds the required limit, prescribed in the GB/T26572-2011 standards.

Based on the provided information, the product contains hazardous material. Due to the limitation of the existing technology, the hazardous material cannot be replaced, although we have been striving to improve this situation. The product has the Environmental Friendly Use Period (EFUP) of 10 years.

The EFUP is valid only when the user operates in normal conditions as specified in the user manual.

Indicative description of Regulations on Regulation on Recycling and Disposal of Waste Electrical and Electronic Products..

When you will not use this product anymore or warranty is expired, please dispose / send this product to the qualified recycling station near your area. It is ordered / regulated by the Regulation on Recycling and Disposal of Waste Electrical and Electronic Products.

INSTALLATION

Installation Tools

The following tools may be required depending on your installation.

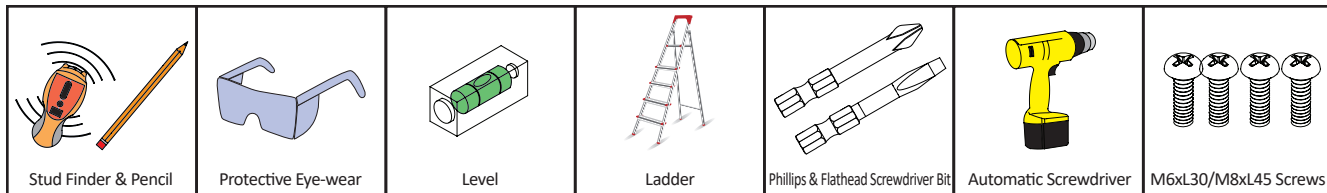

Assembly Components - provided

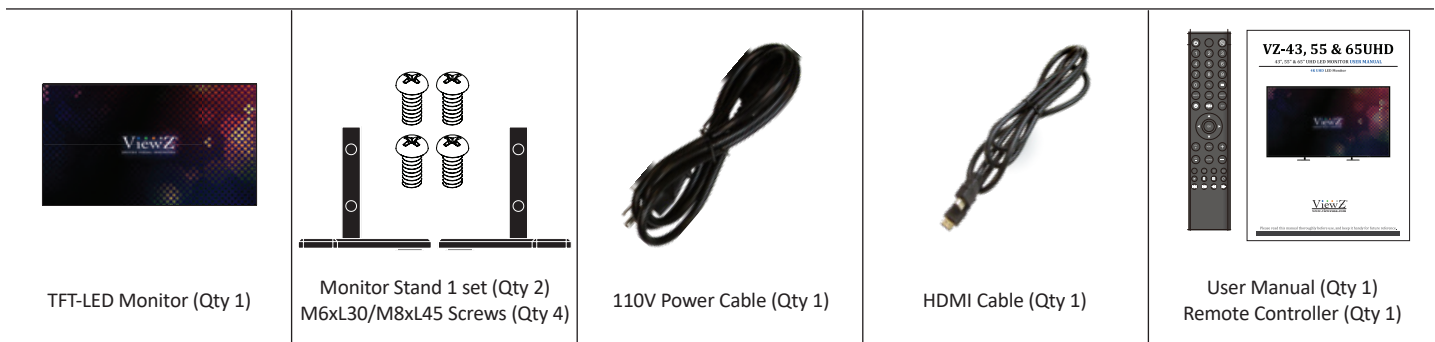

Your ViewZ monitor is shipped with all proper installation hardware and components. If there are parts missing and/or damaged, please stop the installation and contact ViewZ USA at (888)-998-4399.





Mounting Option

VZ-43, 55 & 65UHD is VESA compliant and compatible with ViewZ monitor mounts. For more information, please contact ViewZ USA at (888)-998-4399.

Compatible ViewZ Wall Mount

- | | | | |
|--|---|---|--|
| <ul style="list-style-type: none"> Part # WM71  | <ul style="list-style-type: none"> Tilting $-10^{\circ} \sim 0^{\circ}$ Universal Mount Load Capacity
165 lbs / 75 kg | <ul style="list-style-type: none"> Part # XMS  | <ul style="list-style-type: none"> Tilting Hor. $\pm 3^{\circ}$ Ver. $- 2^{\circ} \sim +4^{\circ}$ Universal Mount Load Capacity
154 lbs / 70 kg |
|--|---|---|--|

Compatible ViewZ Ceiling Mount

- | | | | |
|--|---|---|--|
| <ul style="list-style-type: none"> Part # CMKIT-04  | <ul style="list-style-type: none"> Tilting $-12^{\circ} \sim +5^{\circ}$ Rotation 360° Universal Mount Load Capacity
110 lbs / 50 kg | <ul style="list-style-type: none"> Part # VZ-FSM2x2  | <ul style="list-style-type: none"> Tilting $\pm 4^{\circ}$ Universal Mount Load Capacity
110 lbs / 50 kg |
|--|---|---|--|

STAND INSTALLATION

Stand Installation

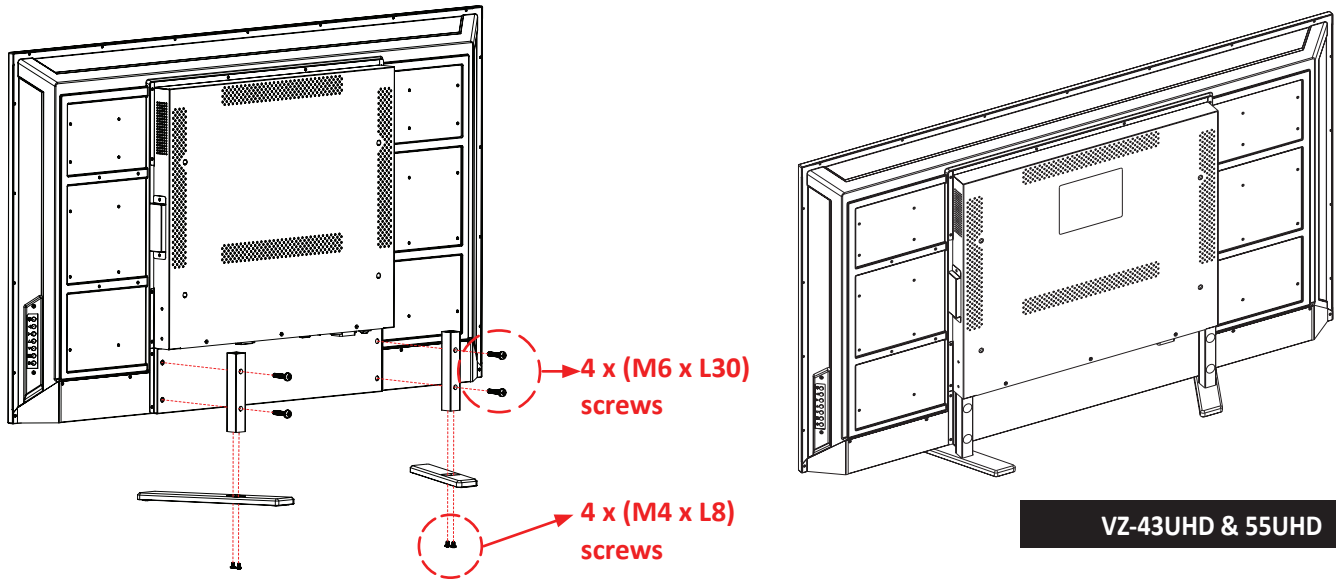

1. Slot each stand into bottom holes of VZ-43 & 55UHD as shown.
2. Align the holes between stand and VZ-43 & 55UHD & Tighten provided screws (M6 x L30mm) into the holes.

! **Attention!** VZ-43& 55UHD : You must use 4 * M6 x L30 mm screws to assemble this monitor and the stand.
WARNING ! If the user uses longer screws than M6 x L30 mm, it may damage the unit.

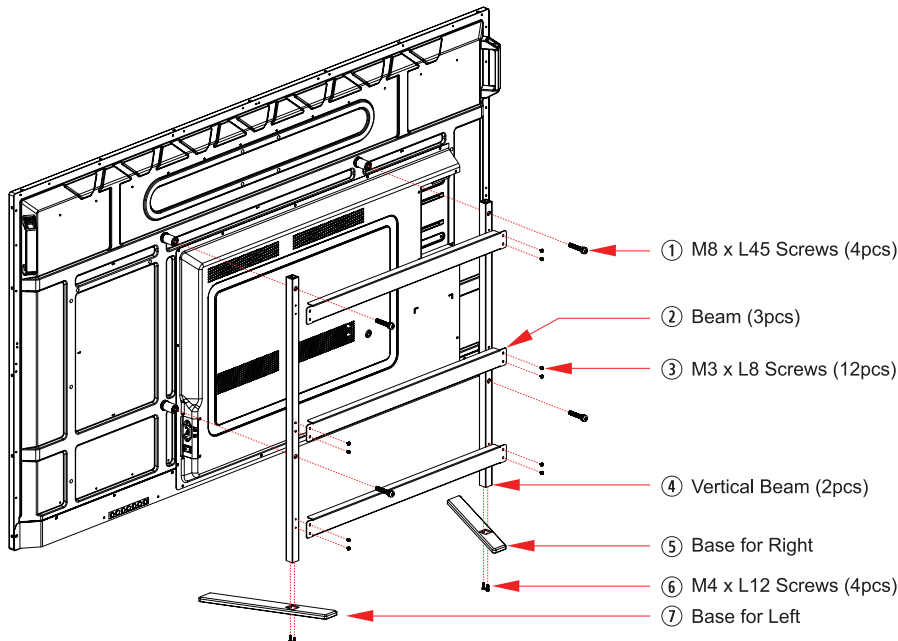

! **Attention!** VZ-65UHD : You must use 4 * M8 x L45 mm screws to assemble this monitor and the stand.
WARNING ! If the user uses longer screws than M8 x L45 mm, it may damage the unit.



Mounting Safety !

At least two people are recommended to install the mount.

CONNECTING WITH EXTERNAL EQUIPMENT

Interface Input Ports

The following image is the description of interface input ports of VZ-43, 55 & 65UHD

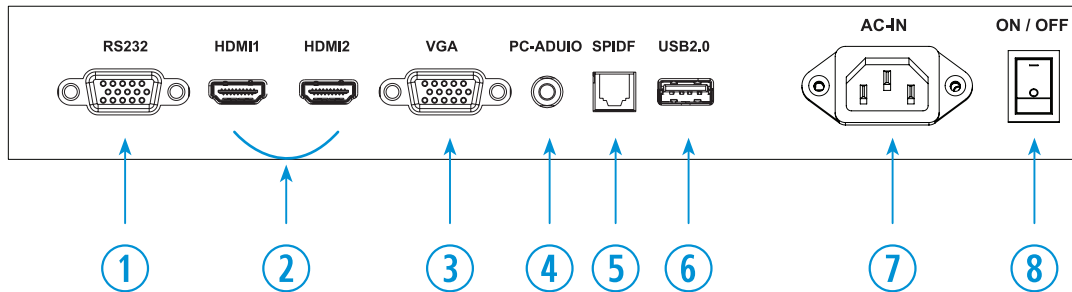

1. RS232 IN
2. HDMI x 2 IN (Ver 2.0)
3. VGA IN
4. PC Audio IN
5. SPDIF IN
6. USB 2.0 IN
7. AC 110V
8. Power On/Off

Interface Resolution & Refresh Rate

Interface Input Source	Max Resolution	Refresh Rate
HDMI (Ver. 2.0)	3840 x 2160	60Hz
VGA	1920 x 1080	60Hz

REMOTE FUNCTION

Remote Controller

1. **POWER** - Power On & Off
2. **SMARTS** - Change the sound mode
3. **INFO** - Display signal type
4. **TIME** - Set the time to turn off the monitor
5. **BACK** - Exit or return to the previous menu
6. **VOLUME (+/-)** - Set the volume
7. **COLOR** - Set the color temperature
8. **USB (Media Player)** - Play, Pause, Stop, Rotate, Previous, Next, Rewind & Fast Forward
9. **MUTE** - Mute audio
10. **F1** - Freeze the monitor display
11. **SMARTP** - Change the image mode
12. **16:9** - Change the display mode
13. **ARROW** - OSD control
14. **OK** - Current OSD value confirm
15. **MENU** - Enter the OSD
16. **SOURCE** - Change the input source

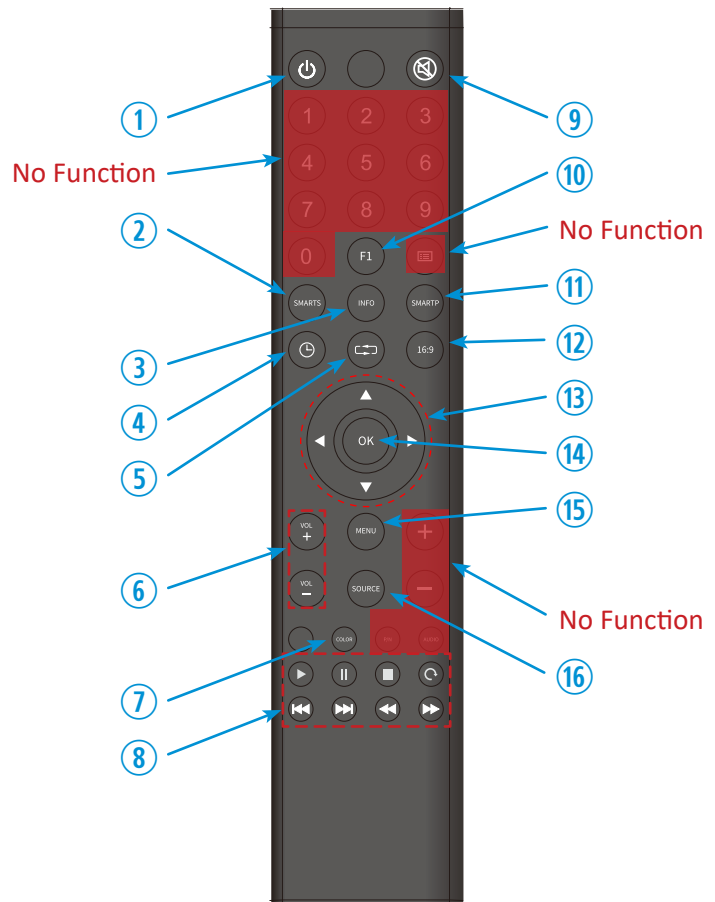

Display image, sound and custom settings can be adjusted in OSD (On Screen Display) menu by remote controller.
To adjust monitor setting value :

1. Press the **MENU** button to enter the OSD menu
2. Press the **SOURCE** button to select input source
3. Press the **▲ / ▼** buttons to select the desired **sub MENU**. The selected **sub MENU** will be highlighted
4. Press the **ENTER** button to enter the **sub MENU** for adjusting items
5. Change the value you wish to adjust by using the **◀ / ▶** buttons
6. Press the **ENTER** button to confirm / Press the **EXIT/BACK** button to exit & save adjustment value on **sub MENU**
7. Press the **MUTE** button to mute audio - audio only works with a selected input source

CONTROL AND FUNCTION

On Monitor, Button Control

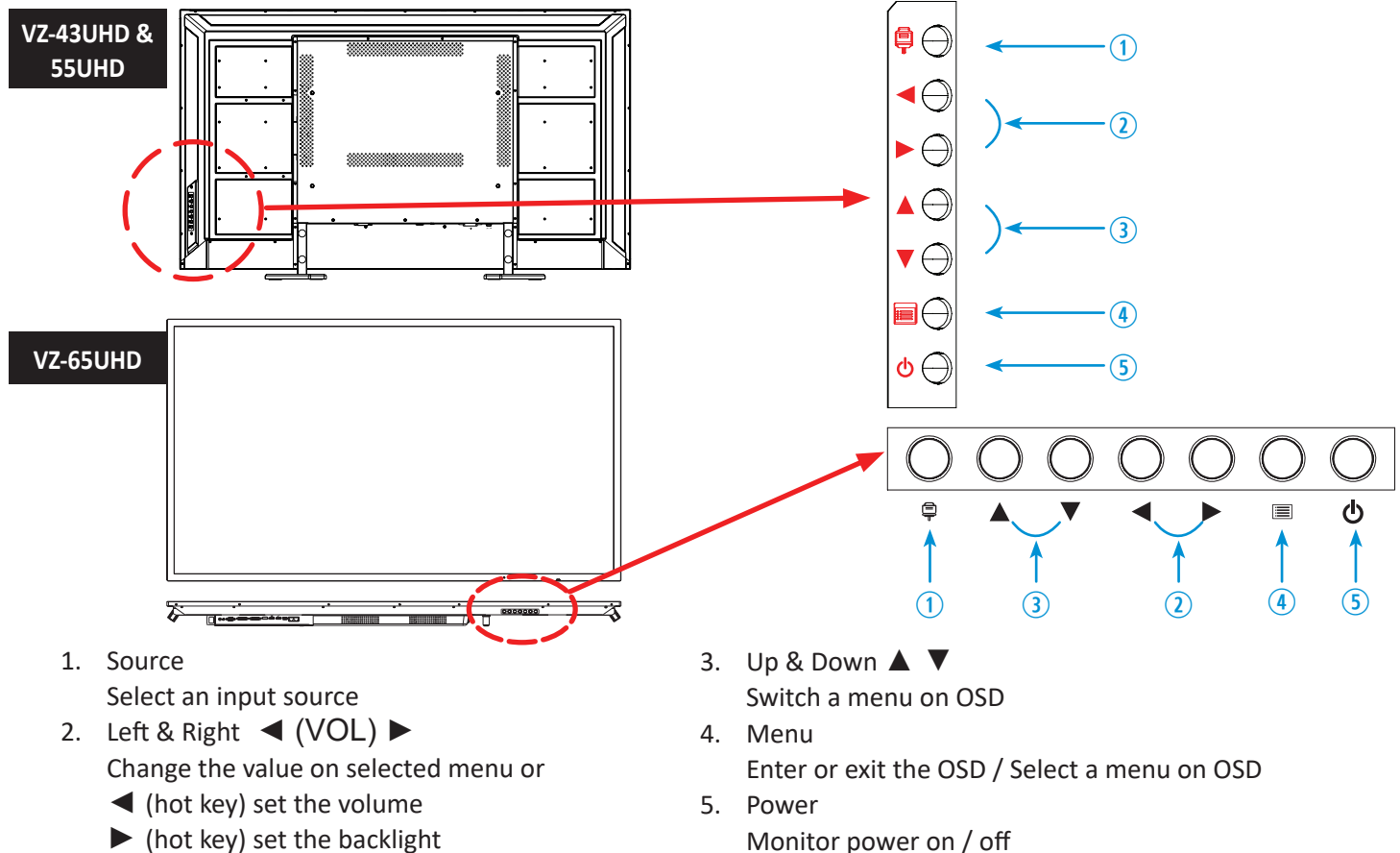

Monitor Button Function

All picture, sound settings and setup can be adjusted in OSD (On Screen Display) menu.
To adjust the OSD screen:

1. Press the **MENU** button to enter the **OSD MENU**
2. Press the **SOURCE** button, then press the ▲ / ▼ buttons to select input source
Press the **SOURCE** button to select a desired input source
3. Press the ◀ / ▶ buttons to select the desired **main MENU**. The selected **main MENU** is highlighted
4. Press the ▲ / ▼ buttons to select the desired **sub MENU**. The selected **sub MENU** is highlighted
5. Change the value you wish to adjust by using the ◀ / ▶ buttons
6. Press the **MENU** button to confirm the adjustment on **sub MENU**
7. Press the **MENU** button to exit the **sub MENU** and go back to the **main MENU**
8. Press the **MENU** button to exit the **OSD MENU**

CONTROL AND FUNCTION

Select Input Source

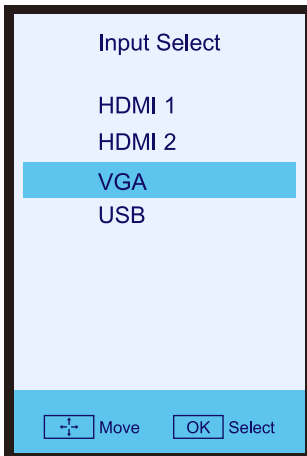

Press 'SOURCE' button on monitor or the remote controller.

Press ▲/ ▼ button to change input source and then press 'MENU' button to select input source on monitor.

Press ▲/ ▼ button to change input source and then press 'OK' button to select input source on remote controller.

Detect Source Signal Message

If you connect any input source, monitor will display current input source resolution and frequency.

Volume

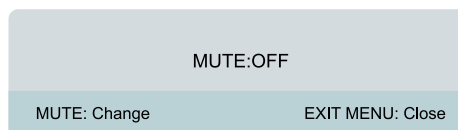

Press 'Mute' button on the remote controller to mute the sound.

CONTROL AND FUNCTION

Volume



Press ▼ button on the monitor first, and then press ◀ / ▶ buttons to adjust volume on the monitor.

CONTROL AND FUNCTION

PICTURE

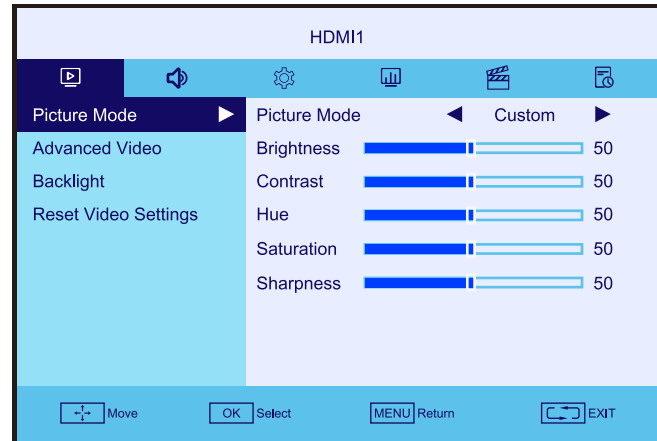
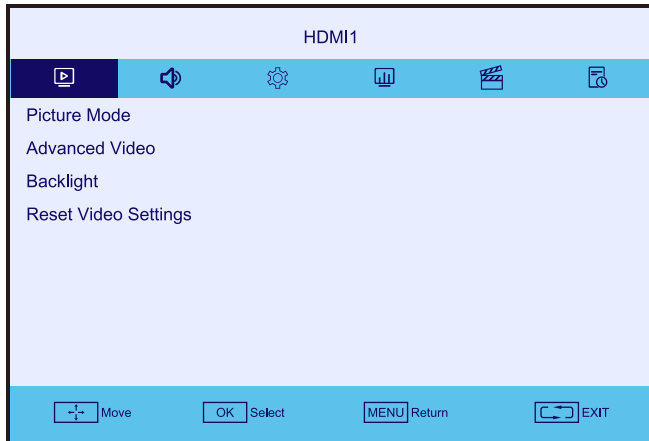

FUNCTION		VALUE
PICTURE MODE	Adjust the image color setting	
STANDARD	Provide standard contrast and sharpness	
SOFT	Reduce contrast and sharpness	
EYE CARE	Provide blue light filter	
BRIGHT	Provide enhanced contrast and sharpness	
CUSTOM ¹⁾	Apply user selected values (0 ~ 100)	CONTRAST / BRIGHTNESS / HUE / SHARPNESS / SATURATION
BACKLIGHT	Adjust the monitor backlight level	0 ~ 100 (default: 0)
RESET VIDEO SETTINGS	Reset the monitor settings to the factory default	YES / NO

1) Contrast - Adjust the contrast

Brightness - Adjust the brightness

Hue - Adjust the red, green and blue brightness level

Sharpness - Adjust the sharpness

Saturation - Adjust the color value

CONTROL AND FUNCTION

PICTURE

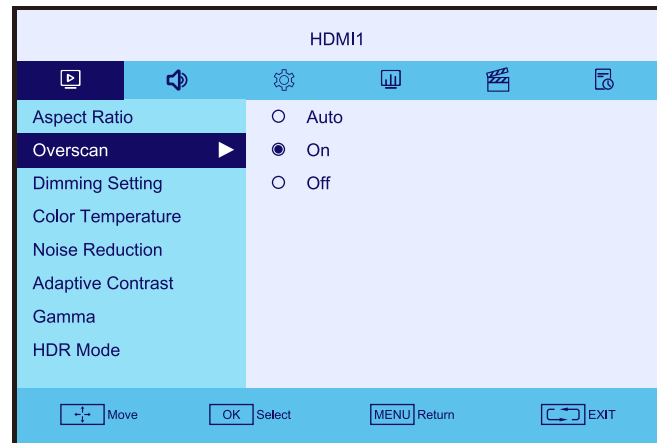
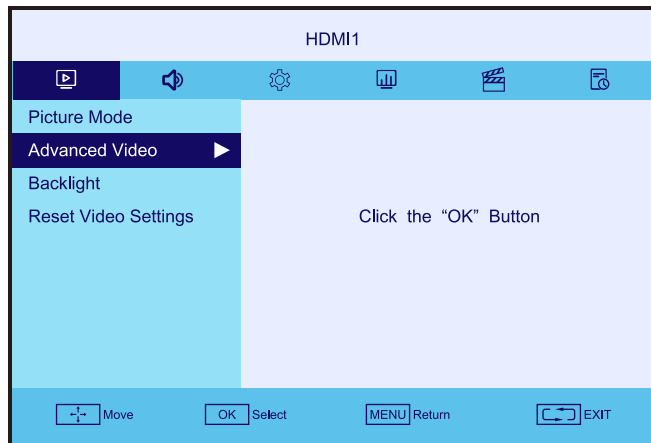

FUNCTION		VALUE
ADVANCED VIDEO	Adjust the video setting	
ASPECT RATIO	Adjust the video format	Normal / 1:1 / Full / Zoom (default: Normal)
OVERSCAN	Cut off the edge of display	AUTO / ON / OFF (default: OFF)
DIMMING SETTING	Setup the dynamic backlight	Dynamic Backlight / OFF
COLOR TEMPERATURE	Adjust the color setting	
COOL	Give the white color a blue-ish tint	
NORMAL	Give the white color a neutral tint	
WARM	Give the white color a reddish tint	
CUSTOM	Apply user selected values	Red 0 ~ 255, Green 0 ~ 255 Blue 0 ~ 255
NOISE REDUCTION	Estimates the amount of noise automatically and applies suitable noise reduction processing	OFF / LOW / MID / HIGH (default: OFF)
ADAPTIVE CONTRAST	Adjust contrast	OFF / LOW / MID / HIGH (default: OFF)
GAMMA	Adjust the brightness of monitor	NATIVE / 2.2 / 2.4 (default: 2.2)
HDR MODE	The HDR let the display reproduce a greater dynamic range of luminosity, allowing lighter & darker details to be displayed clearly	LOW / MID / HIGH (default: MID)

CONTROL AND FUNCTION

SOUND

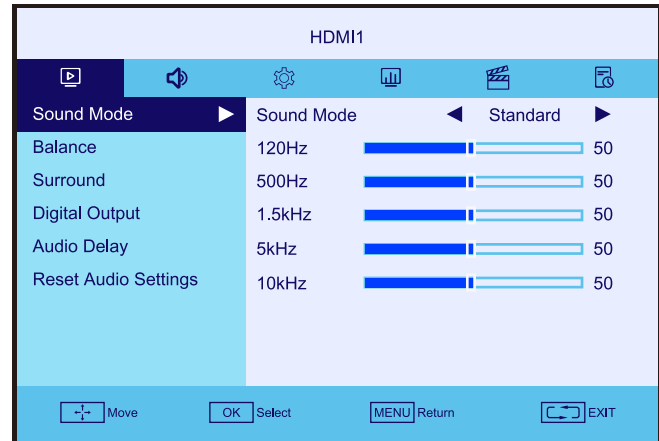
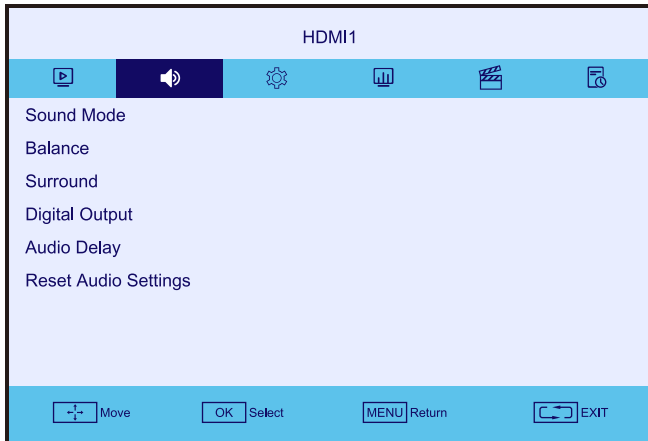

FUNCTION		VALUE
SOUND MODE	Set the sound effect	STANDARD / ROCK / POP / JAZZ / CLASSICAL / CUSTOM (default: STANDARD)
BALANCE	Adjust the balance	L 0 ~ 50 / R 0 ~ 50 (default: 0)
SURROUND	Set the surround sound	ON / OFF (default: OFF)
DIGITAL OUTPUT	Set the audio output format	RAW / PCM (default: RAW)
AUDIO DELAY	Adjust the audio output delay	0 ~ 100 (default: 0)
RESET AUDIO SETTINGS	Reset the monitor settings to the factory default	YES / NO

CONTROL AND FUNCTION

SETTINGS

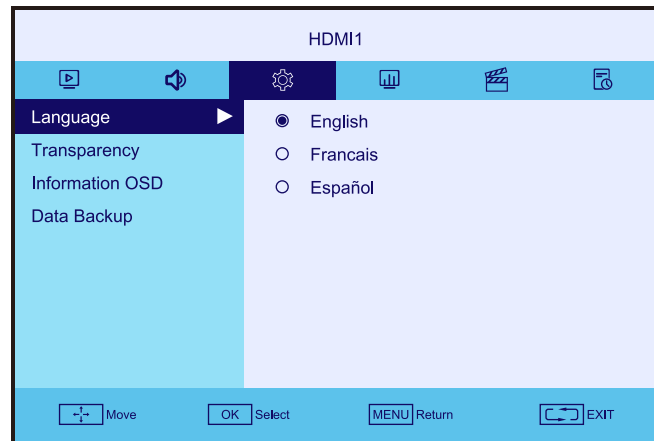
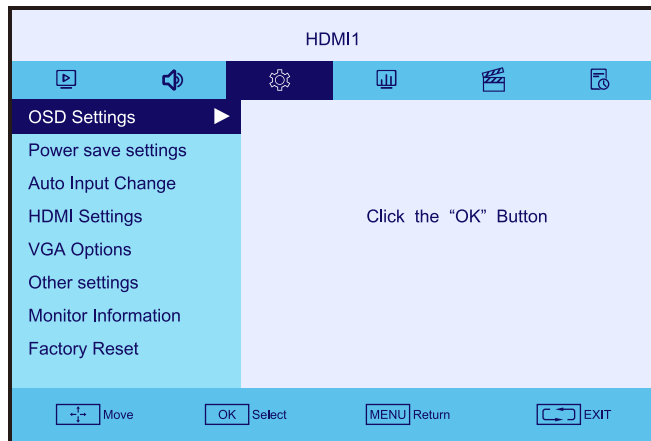

	FUNCTION	VALUE
OSD SETTINGS	Adjust OSD preferences	
LANGUAGE	Set the language of the OSD menu	English / French / Spanish (default: English)
TRANSPARENCY	Set the OSD transparency	OFF / 25% / 50% / 75% (default: OFF)
INFORMATION OSD	Display the monitor information	OFF / ON (default: ON)

CONTROL AND FUNCTION

SETTINGS

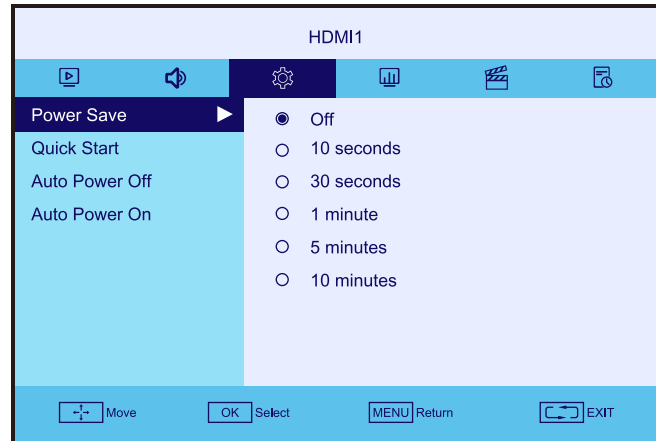
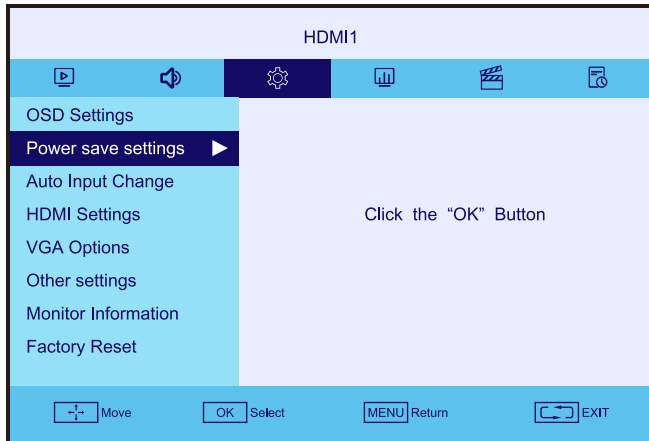

	FUNCTION	VALUE
POWER SAVE SETTINGS		
POWER SAVE	Adjust the power saving mode of monitor	OFF,10s,30s,1m,5m,10min
QUICK START	Setup the quick starting mode	OFF / ON (default: OFF)
AUTO POWER	Setup the automatic power on / off	OFF / ON (default: OFF)
AUTO INPUT CHANGE	Change the automatic input source	OFF / FIRST / CUSTOM
HDMI SETTINGS		
CEC	Set the HDMI Consumer Electronics Control (CEC)	OFF / ON (default: OFF)
EDID	Set the Extended Display Identification Data (EDID) Switch the max resolution ratio	MODE 0 (HDMI 1.3) / MODE 1 (HDMI 1.4) / MODE 2 (HDMI 2.0)
VIDEO RANGE	Set the color range of HDMI video signal	AUTO / RAW SIGNAL / EXPANDED SIGNAL
HPD DELAY	Set the embedded HDMI hot plug timing response	OFF / ON (default: OFF)
VGA OPTIONS		
AUTO ADJUST	Fit the image size automatically	OFF / ON (default: OFF)
H / V. POSITION	Adjust the horizontal / vertical position of picture	L50~R50/B50~T50 (default: 0)
CLOCK	Adjust the number of horizontal picture elements	0 ~ 100 (default: 50)
PHASE	Adjust the vertical noise of screen image	0 ~ 100 (default: 50)
H / V. RESOLUTION	Adjust the horizontal / vertical resolution of picture	-50 ~ 50 (default: 0)
RESET VGA OPTIONS	Reset the monitor settings to the factory default	YES / NO (default: NO)

CONTROL AND FUNCTION

SETTINGS

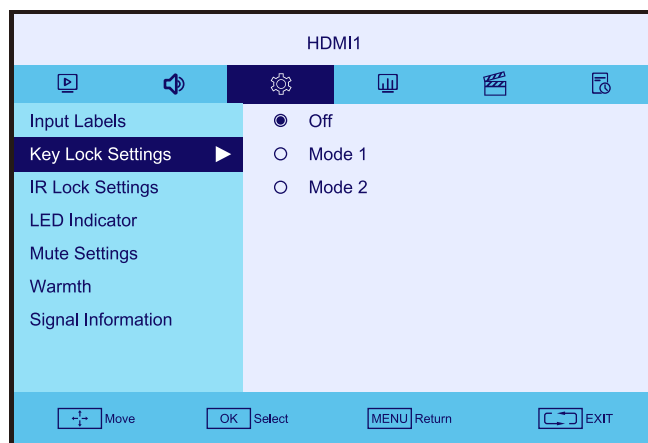
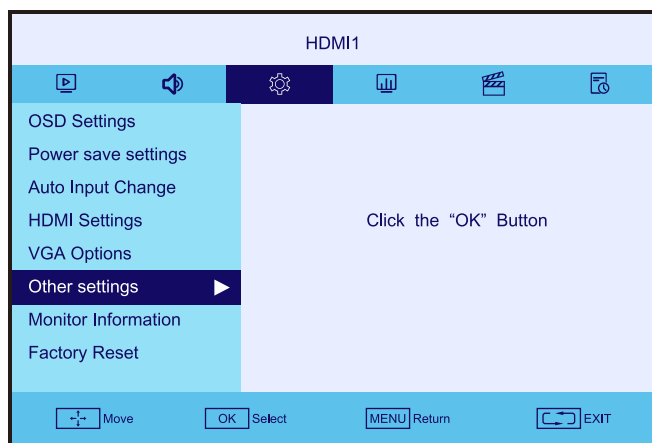

	FUNCTION	VALUE
OTHER SETTINGS	Setup OSD	
INPUT LABELS	Change the input source label	
KEY LOCK SETTINGS	Enable / disable OSD key button MODE 1: Except Power button, all buttons are disable MODE 2: All buttons are disable ¹⁾	OFF / MODE 1 / MODE 2 (default: OFF)
IR LOCK SETTINGS	Enable / disable IR sensor MODE 1: Except Power button, all buttons are disable MODE 2: All buttons are disable ²⁾	OFF / MODE 1 / MODE 2 (default: OFF)
LED INDICATOR	Set the power indigator on/off	OFF / ON (default: ON)
MUTE SETTINGS	Turn on/off audio & video	AUDIO / VIDEO (default: AUDIO)
WARMTH	Set the automatic turn-off temperature of monitor If the monitor temperature rise over 42°C (1 st gear) & 45°C (2 nd gear), the monitor will be automatically shutdown. When the monitor temperature cool down under 42°C (1 st) & 45°C (2 nd), the monitor will automatically turn on.	OFF / 1 st GEAR (42°C) / 2 nd GEAR (45°C) (default: OFF)
SIGNAL INFO.	Display the input signal information	

1) To unlock this mode, press 'MENU' button & hold for 5 seconds - on the monitor. Refer to page 12's monitor buttons.

2) To unlock this mode, press 'BACK' button & hold for 5 seconds - on the remote controller. Refer to page 11's remote controller.

CONTROL AND FUNCTION

SETTINGS

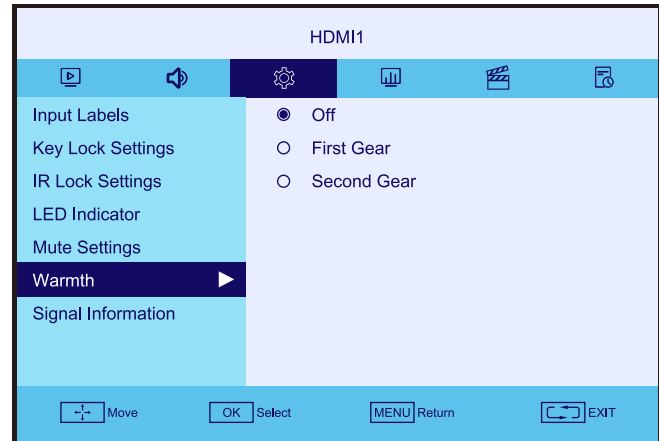
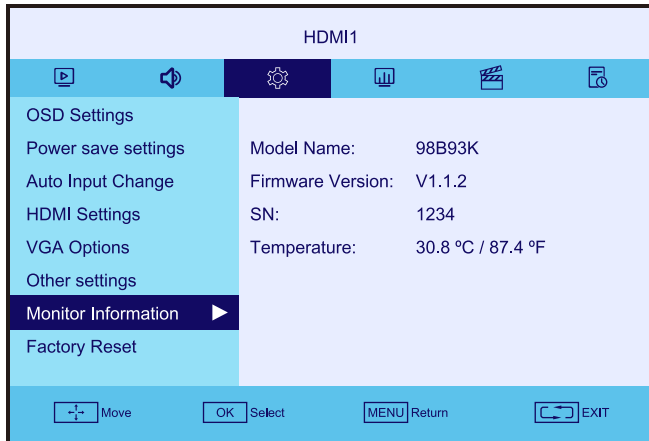

	FUNCTION	VALUE
MONITOR INFO.	Display the monitor information Current monitor model name, firmware version, serial number, temperature	
FACTORY RESET	Reset the monitor settings to the factory default	YES / NO

CONTROL AND FUNCTION

CONTROL & MEDIA

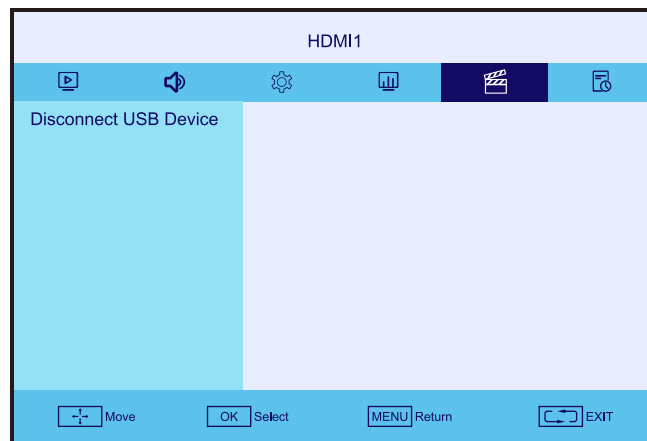
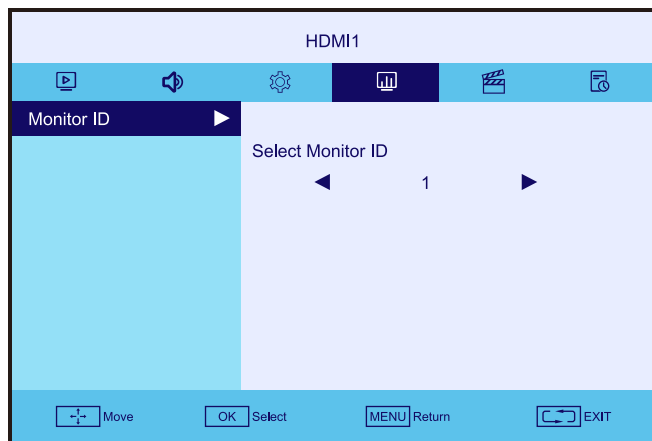

	FUNCTION	VALUE
MONITOR ID	Select the monitor ID	1 ~ 100 (default: 1)

	FUNCTION	VALUE
DISCONNECT USB DEVICE	Disconnect USB device	

CONTROL AND FUNCTION

SCHEDULE

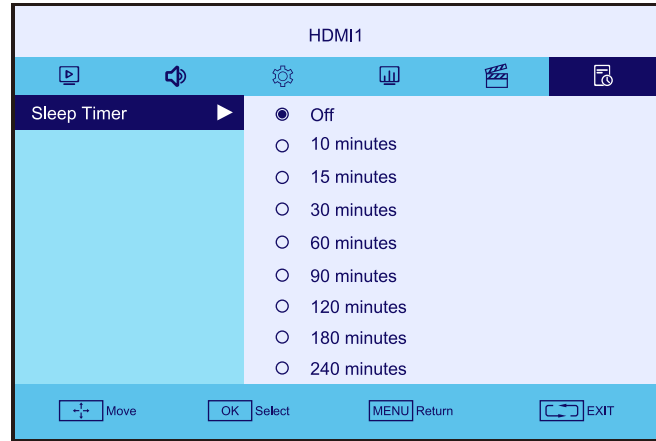
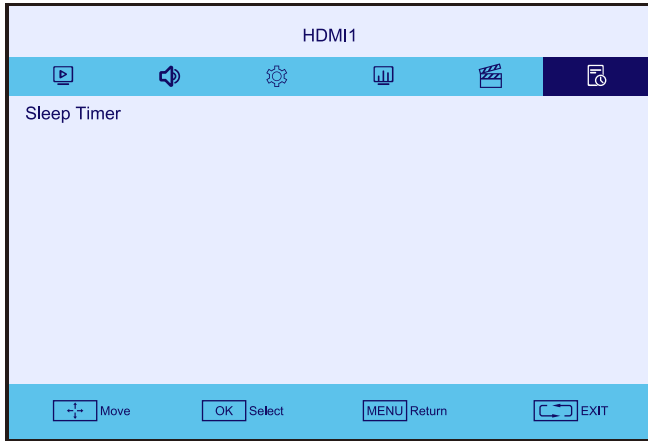

FUNCTION		VALUE
SLEEP TIMER	Setup the time of sleeping mode	OFF / 10 / 15 / 30 / 60 / 90 / 120 / 180 / 240 MINUTES (default: OFF)

CONTROL AND FUNCTION

Media Card Interface

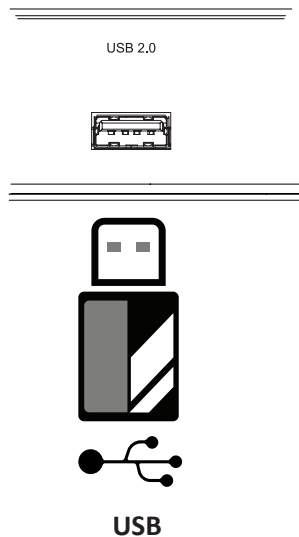

- **Connect USB**
 1. Connect USB device to USB slot located at the back of the UHD
- **Remove USB**
 1. On the OSD menu, select and press 'Disconnect USB device'
 2. Remove the USB from the slot

Media Player OSD

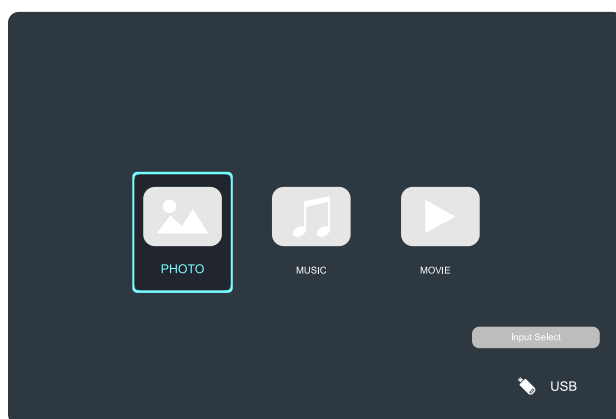

FUNCTION

PHOTO	Displays image files from the USB - Supports JPEG, JPG & PNG
MUSIC	Plays music files from the USB - Supports AAC, FLAC, MP3, OGG, WAV & M4A
MOVIE	Plays video files from the USB - Supports MP4, MOV, MKV, FLV & AVI

CONTROL AND FUNCTION

Photo

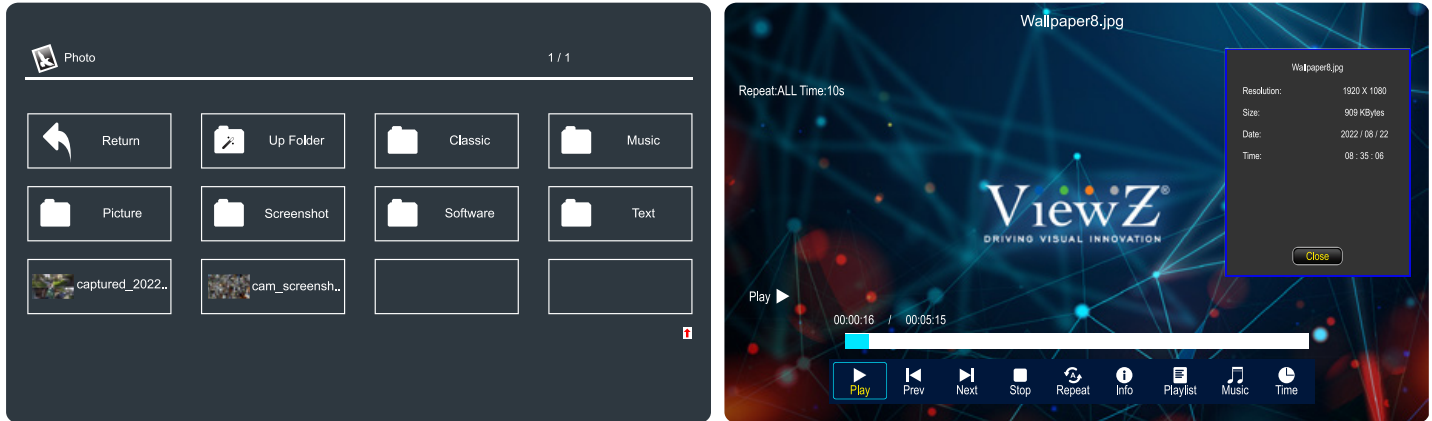

When you select **PHOTO** on the entry menu of Media play:

1. Press the **OK** button and then press ◀ / ▶ / ▲ / ▼ (**ARROW**) buttons to select an image file to display.
2. Press the **OK** button to select image files to play and then press ▶ (**PLAY**) button to display the image or slide-show.
**Note: If you have more than one image file, selected image files will display one by one.*
3. Press || (PAUSE) button to pause the slide-show and show only one image file in a non “slide-show” mode.
4. Press the **Next & Prev** buttons to display next or previous image.
5. Press the **Repeat** button to set repeating time - none (1 time play), 1 (1 more repeat play) and ALL (limitless play).
6. Press the **Info** button to display the image resolution, size, created date and time.
7. Press the **Playlist** button to display the image list which selected.
8. Press the **Music** button to play the music which played on the **MUSIC** of Media player.
9. Press the **Time** button to set the playing time of each image - 5, 10, 15, 30 and 60 seconds.
10. Press the ■ (STOP) button to return to the **Media OSD MENU**

CONTROL AND FUNCTION

Music

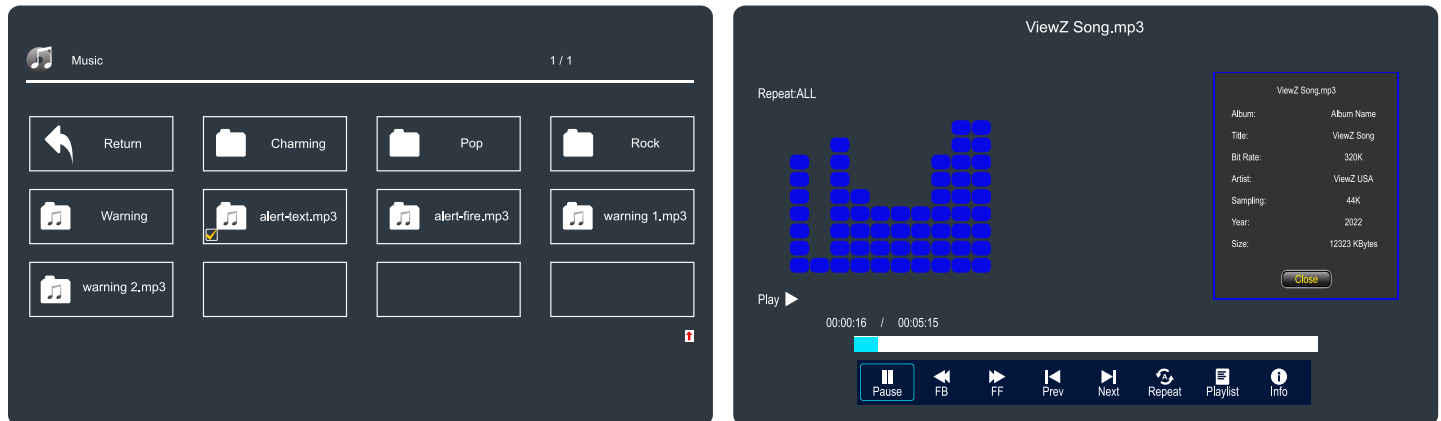

When you select **MUSIC** on the entry menu of Media play:

1. Press the **OK** button and then press ◀ / ▶ / ▲ / ▼ (**ARROW**) buttons to select a music file to display.
2. Press the **OK** button to select music files to play and then press ▶ (**PLAY**) button to play the music.
**Note: If you have more than one music file, selected music files will play one by one.*
3. Press || (**PAUSE**) button to pause the music playing.
4. Press the **FB** (Play Back) & **FF** (Fast Forward) buttons to play or rewind the music - 2, 4, 8 and 16 times
5. Press the **Next & Prev** buttons to play next or previous music.
6. Press the **Repeat** button to set repeating time - none (1 time play), 1 (1 more repeat play) and ALL (limitless play).
7. Press the **Playlist** button to display the music list which selected.
8. Press the **Info** button to display the music album info, title, bit rate, artist name, sampling, year and file size.
9. Press the ■ (STOP) button to return to the **Media OSD MENU**

CONTROL AND FUNCTION

Movie

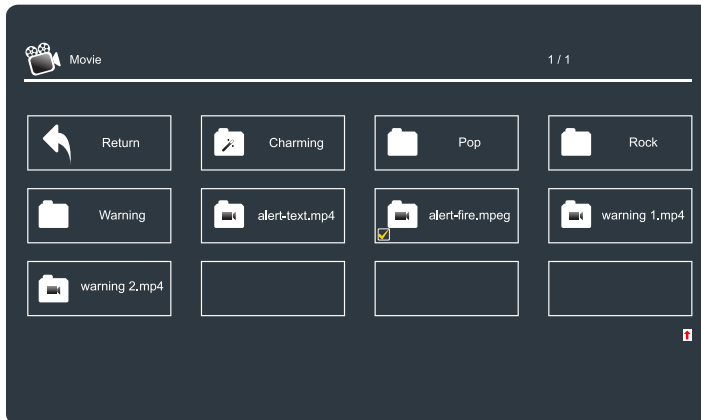

When you select **MOVIE** on the entry menu of Media play:

1. Press the **OK** button and then press ◀ / ▶ / ▲ / ▼ (**ARROW**) buttons to select a movie file to display.
2. Press the **OK** button to select photo files to play and then press ▶ (**PLAY**) button to play the movie.
**Note: If you have more than one movie file, selected movie files will display one by one.*
3. Press || (**PAUSE**) button to pause the movie play.
4. Press the **FB** (Play Back) & **FF** (Fast Forward) buttons to play or rewind the music - 2, 4, 8 and 16 times
5. Press the **Next & Prev** buttons to play next or previous movie.
6. Press the **Repeat** button to set repeating time - none (1 time play), 1 (1 more repeat play) and ALL (limitless play).
7. Press the **Playlist** button to display the movie list which selected.
8. Press the **Info** button to display the movie resolution, movie audio, subtitle, sync, code page, program and file size.
9. Press the ■ (STOP) button to return to the **Media OSD MENU**

RS232 COMMAND

RS 232 Communication Command & Relevant Configurations

In consideration of secondary development of centralized control circumstances, the function of RS232 communication command & relevant configuration setup are described as follow:

- RS 232 communication settings
 - Baud rate : 9600 bps
 - Parity check bit : none
 - Data bit : 8 bits
 - Stop bit : 1 bits

PROTOCOL FRAME							
BYTE	0	1	2	3	4	5	6
NAME	HEAD	LENGTH	ID	CMD TYPE	DATA TYPE	DATA	CR
HEX	1 BYTE	1 BYTE	1 BYTE	1 BYTE	1 BYTE	1 BYTE	1 BYTE

- 0: Head(1 byte): starter frame header fixed EA
- 1: Length (1 byte): total data length, including "CR"
Ex: 0x07 for Length=7; 0x0A for Length=10
- 2: ID (1 byte): the identity of device ID
Ex: ID = 05 for Hex => 0x05;
Ex: Set command with ID="FD" will do the settings to all monitors, and it will not have reply command.
- 3: Command Type (1 byte)
0x73 Set Command Type
0x67 Get Command Type
- 4: Data Type Code (1 byte)
- 5: Command Data Value (at least 1 byte)
- 6: CR (1 byte): Terminator 0x0D

RETURN PACKET							
BYTE	0	1	2	3	4	5	6
NAME	HEAD	LENGTH	ID	CMD TYPE	DATA TYPE	DATA	CR
HEX	0xEA	1 BYTE	1 BYTE	0x20	1 BYTE	n BYTE	0x0D

- Data(1 byte): return data type
0x46 -> OK (Send command successfully)
0x45 -> Error (Sent command is inaccurate)

RS232 COMMAND

RS 232 Communication Command & Relevant Configurations - Set Command

Command format:

Length (1 byte) + ID (1 byte) + Cmd Type (1 byte) + Data Type(1 byte) + Value(>=1 byte) + CR (1 byte)

- Ex: Set Brightness as 176 for ID-02 and this command is invalid

SEND PACKET							
BYTE	0	1	2	3	4	5	6
NAME	HEAD	LENGTH	ID	CMD TYPE	DATA TYPE	DATA	CR
HEX	0xEA	0x07	0x02	0x73	0x60	0xB0	0x0D

RETURN PACKET							
BYTE	0	1	2	3	4	5	6
NAME	HEAD	LENGTH	ID	CMD TYPE	DATA TYPE	DATA	CR
HEX	0xEA	0x07	0x02	0x46	0x60	0xB0	0x0D

RS232 COMMAND

RS 232 Communication Command & Relevant Configurations - Get Command

Command format:

Head (1 byte) + Length (1 byte) + ID (1 byte) + Cmd Type (1 byte) + Data Type(1 byte) + Value(>=1 byte) + CR (1 byte)

- Ex: Get Brightness from ID-05 and this command is valid, and the Brightness value is 67.

SEND PACKET							
BYTE	0	1	2	3	4	5	6
NAME	HEAD	LENGTH	ID	CMD TYPE	DATA TYPE	DATA	CR
HEX	0xEA	0x07	0x05	0x67	0x60	0x00	0x0D

RETURN PACKET							
BYTE	0	1	2	3	4	5	6
NAME	HEAD	LENGTH	ID	CMD TYPE	DATA TYPE	DATA	CR
HEX	0xEA	0x07	0x05	0x46	0x60	0x4C	0x0D

- Ex: Get Power status from ID-05.

SEND PACKET							
BYTE	0	1	2	3	4	5	6
NAME	HEAD	LENGTH	ID	CMD TYPE	DATA TYPE	DATA	CR
HEX	0xEA	0x07	0x05	0x67	0xAE	0x00	0x0D

- Value : 0x00 -> off, 0x01 -> on

RETURN PACKET							
BYTE	0	1	2	3	4	5	6
NAME	HEAD	LENGTH	ID	CMD TYPE	DATA TYPE	DATA	CR
HEX	0xEA	0x07	0x05	0x46	0xAE	0x00/0x01	0x0D

RS232 COMMAND

RS 232 Communication Command & Relevant Configurations

In consideration of secondary development of centralized control circumstances, the POWER ON/OFF function of RS232 communication command & relevant configuration setup are described as follow:

- RS 232 communication settings
 - Baud rate : 9600 bps
 - Parity check bit : none
 - Data bit : 8 bits
 - Stop bit : 1 bits

- RS232 communication command**

PARAMETER (DATA)	DESCRIPTION	SET COMMAND
POWER OFF	RS232 command: 0 x 00	EA 07 [ID] 73 AE [Data] 0D
POWER ON	RS232 command: 0 x 01	
VOLUME UP	RS232 command: 0 x C7	EA 07 [ID] 73 [Data] 00 0D
VOLUME DOWN	RS232 command: 0 x C8	
VOLUME VALUE	RS232 command: 0 x 00-64	
HDMI1	RS232 command: 0 x 00	EA 07 [ID] 73 50 [Data] 0D
HDMI2	RS232 command: 0 x 01	
USB	RS232 command: 0 x 05	
VGA	RS232 command: 0 x 06	
ENGLISH	RS232 command: 0 x 00	EA 07 [ID] 73 55 [Data] 0D
FRENCH	RS232 command: 0 x 02	
SPANISH	RS232 command: 0 x 03	
		EA 07 [ID] 73 D0 00 0D
OFF	RS232 command: 0 x 00	EA 07 [ID] 73 77 [Data] 0D
ON	RS232 command: 0 x 01	
STANDARD	RS232 command: 0 x 00	EA 07 [ID] 73 A1 [Data] 0D
SOFT	RS232 command: 0 x 01	
BRIGHT	RS232 command: 0 x 02	
CUSTOM	RS232 command: 0 x 03	
WARM	RS232 command: 0 x 04	
64 / 0-100	RS232 command: 0 x 00	EA 07 [ID] 73 62 [Data] 0D EA 07 [ID] 73 61 [Data] 0D EA 07 [ID] 73 60 [Data] 0D EA 07 [ID] 73 6A [Data] 0D EA 07 [ID] 73 6E [Data] 0D EA 07 [ID] 73 6D [Data] 0D
COOL	RS232 command: 0 x 00	EA 07 [ID] 73 AD [Data] 0D
STANDARD	RS232 command: 0 x 01	
WARM	RS232 command: 0 x 02	
CUSTOM	RS232 command: 0 x 03	
FF / 0-255	RS232 command: 0 x 00	EA 07 [ID] 73 64 [Data] 0D EA 07 [ID] 73 65 [Data] 0D EA 07 [ID] 73 66 [Data] 0D

The above commands are hexadecimal.

MOUNTING GUIDE

Wall Mounting (Optional)

VZ-43,55&65UHD monitors are suitable for universal wall mounting (not included).

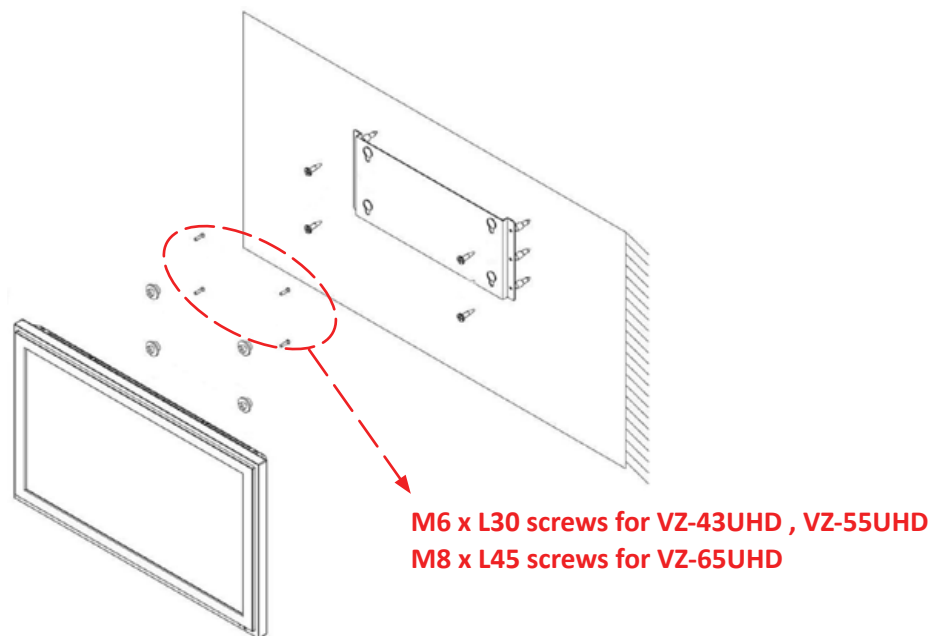

1. VZ-43UHD : Universal Wall Mount (VESA) 400mm x 200mm
2. VZ-55UHD : Universal Wall Mount (VESA) 400mm x 400mm
3. VZ-65UHD : Universal Wall Mount (VESA) 600mm x 400mm

! WARNING !

If user uses screws longer than
M6 x L25-33 mm for VZ-43UHD,
M6 x L28 mm for VZ-55UHD,
M8 x L30 mm for VZ-65UHD,
it may cause damage to the unit. Please use the screws of correct and size and length as instructed.



Mounting Safety !

At least two people are recommended to safely install the mount and monitor.

SPECIFICATION

Model No.	VZ-43UHD	VZ-55UHD	VZ-65UHD	
Size & Type	43"	55"	65"	
LCD	Panel Type	43" 4K LED Backlit Monitor	55" 4K LED Backlit Monitor	65" 4K LED Backlit Monitor
	Pixel Pitch	0.2451 (H) x 0.2451 (V) mm	0.315 (H) x 0.315 (V) mm	0.372 (H) x 0.372 (V) mm
	Brightness	350 cd/m ² (Typical)	350 cd/m ² (Typical)	400 cd/m ² (Typical)
	Contrast Ratio	1200 : 1(Typ.)	1200 : 1(Typ.)	1200 : 1(Typ.)
	Viewing Angle		178° / 178°	
	Display Color	1.07 Billion Colors (10 Bit)		
	Response Time	< 8 ms	< 8 ms	< 8 ms
	Active Display Area	941.184 (H) x 529.416 (V) mm	1209.6 (H) x 680.4 (V) mm	1428.48 (H) x 803.52 (V) mm
	Resolution	3840 (H) x 2160 (V) @ 60Hz		
	Refresh Rate (Max.)	HDMI 2.0 - 3840x2160 @60Hz VGA - 1920x1080 @60Hz		
Aspect Ratio	16 : 9			
Case Type	Black Metal			
Color Temperature	Standard (10000) / Warm (7500) / Cool (13000) / USER			
Speaker	2 x 10W	2 x 10W	2 x 10W	
Operating Temperature	32°F ~ 104°F / 0°C ~ 40°C			
Operating Humidity	20 ~ 85% RH			
Weight	Net : 25.79 lbs / 11.7 kg	Net : 35.49 lbs / 16.1 kg	Net : 62.83 lbs / 28.5 kg	
	Gross : 31.30 lbs / 14.2 kg	Gross : 43.65 lbs / 19.80 kg	Gross : 89.28 lbs / 40.5 kg	
INTERFACE	HDMI 2.0 x 2, VGA (15PIN D-Sub) x 1, PC Audio In x 1, RS232 (9PIN D-Sub) In x 1, SPDIF In x 1, USB In x 1, OPS In x 1 (Option)			
Safety & EMC Certification	FCC / RoHS			
Electrical Ratings	AC 100-240V, 50/60Hz			
Power Consumption	≤ 85W	≤ 140 W	≤ 170 W	
Accessories	AC 110V Power Cable, HDMI Cable, User's Manual, Remote Controller, Stand			

TROUBLESHOOTING GUIDE

- Check the following before calling for service.
- If the same problems continue after checking, contact the reseller you purchased the monitor from.

At start	We recommend that you test with different input sources when you have trouble with the current input source. If symptom persists, follow the instructions below. After following the instructions below, please contact us at 1-888-99-VIEWZ.
No image or Noise on the screen	<ul style="list-style-type: none"> - Make sure the cable is correctly plugged into the outlet. - Make sure the power cable is correctly plugged into the monitor. - Make sure the cable is correctly connected between monitor & source - - Check brightness and see if brightness is set to 'Ø'. - Check video source.
Incorrect display or Half display	<ul style="list-style-type: none"> - Check your video source. - Reset video source : connection, cable replacement, setting & more.
Flickering and shadow image	<ul style="list-style-type: none"> - Check your input source setting for resolution and phase (Hz).
The audio function is not working	<ul style="list-style-type: none"> - Check the volume and make sure MUTE is not on. - Check HDMI / BNC / Audio port cable connection.
LED is flickering or no image	<ul style="list-style-type: none"> - Check the interface cable connection and make sure it's plugged in correctly. - Check the input source.

TERMS OF WARRANTY / RMA

- The warranty period for this monitor is 3 years. The warranty will be voided for the scenarios listed below.
- You can also download the manual and information of VIEWZ web site: VIEWZUSA.COM

Cases of Non-Warranty Coverage	When power feed to the monitor exceeds capacity and causes damage.
	Accident, Abuse, Misuse, Neglect, Fire, Water/liquids, Lightning or any act of nature.
	Damaged by dropping, throwing and hitting the monitor.
	Failure caused by users attempt to modify the product.
	Failure by limited life of parts such as LED Lamps and any other consumables.
	Damaged by using third party power cable, unstable power input and electric shock.

* Above information can be changed without notification - please check our website or contact ViewZ representative for latest RMA service policy.

* When shipping the monitor for RMA, make sure to pack safely to ensure the monitor is not damaged during shipping.

WARRANTY

ViewZ USA LIMITED 3 YEAR WARRANTY

What and Who is Covered by this Limited Warranty and for How Long

ViewZ USA warrants this product to be free from defects in material and workmanship for 3 years to the original owner of this product. The limited warranty is valid only for the original purchaser of the product.

What ViewZ USA Will Do

At their sole discretion, ViewZ USA will repair or replace any product or product part that is defective. If ViewZ USA chooses to replace a defective product or part, a replacement product or part will be shipped to you at no charge, but you must pay any labor costs.

What is Not Covered; Limitations

ViewZ USA disclaims any liability for damage to mounts, adapters, displays, projectors, other property, or personal injury resulting, in whole or in part, from improper installation, modification, use or misuse of its products.

ViewZ USA disclaims all other warranties, express or implied, including warranties of merchantability and fitness for a particular purpose. ViewZ USA is not responsible for incidental or consequential damages, including but not limited to, inability to use its products or labor costs for removing and replacing defective products or parts. Some states do not allow the exclusion or limitation of incidental or consequential damage, so the above limitation or exclusion may not apply to you.

What Customers Must Do for Limited Warranty Service

If you discover a problem that you think may be covered by the warranty you MUST REPORT it in writing to the address below within thirty (30) days. Proof of purchase (an original sales receipt) from the original consumer purchaser must accompany all warranty claims. Warranty claims must also include a description of the problem, the purchaser's name, address, and telephone number. General inquiries can be addressed to ViewZ USA Customer Service at 1-888-998-4399. Warranty claims will not be accepted over the phone or by fax.

ViewZ USA
Attn: Warranty Claim
177 W. Orangethorpe Ave.
Placentia, CA 92870

How State Law Applies

This warranty gives you specific legal rights, and you may also have other rights which vary from state to state.

Disclaimer

ViewZ USA intends to make this manual accurate and complete. However, ViewZ USA makes no claim that the information contained herein covers all details, conditions or variations, nor does it provide for every possible contingency in connection with the installation or use of this monitor. The information contained in this document is subject to change without notice or obligation of any kind. ViewZ USA makes no representation of warranty, expressed or implied, regarding the information contained herein. ViewZ USA assumes no responsibility for accuracy, completeness or sufficiency of the information contained in this document.

Contact Us

NORTH AMERICA

177 W. Orangethorpe Ave.
Placentia, CA 92870
USA and Canada
Phone: 1-888-998-4399
Fax: 1-714-996-1138
Other Locations
Phone: (001) 888-998-4399
Fax: (001) 714-996-1138